



► RT-50 Flow Transmitter

Installation, Operating & Maintenance Manual

Table of Contents

Unpacking	3
Quick Start Guide	3
Power	3
Installation	3
Product Description	4
Technical Specifications	4
Battery Replacement	5
Navigational Buttons	5
Run Mode Screens	6
Programming Menu Navigation	6
K-Factor	6
Rate	7
Total	7
Contract Time	7
Linearizer.....	8
Input/Output.....	8
System	8
Compter Toolkit	10
Connecting	10
Upgrading Firmware	11

Safety Definitions and Information

Do not attempt to install or use your AW Gear Meters product until you have read the safety instructions in this section. Save this manual and keep it in an easily accessible place.

WARNING means that failure to follow this safety statement may result in extensive product damage, serious personal injury, or death.

CAUTION means that failure to follow this safety statement may result in minor or moderate personal injury, property or equipment damage.

NOTICE is a statement that informs about installation, operation, maintenance, performance issues, or general tips that are important but do not create a hazard or safety concern.

Unpacking

Separate the RT-50 Flow Display from packaging materials and check for any visual signs of damage. If you determine there are damages caused by shipping, file a claim with the shipping company. If the flow monitor appears to have been improperly assembled or does not operate properly, Contact AW Lake's returns department for replacement or repair.

Quick Start Guide

CAUTION: As with any precision-engineered device, always use the RT-50 in accordance with the manufacturer's instructions.

Power

3 lithium batteries provide the power to the RT-50. Units must be shipped with the battery unplugged. To power On, plug in the battery to the designated socket on the board marked BAT (See Figure 1). To replace the battery, refer to Changing the Battery on page 4.

Installation

Secure display to flow meter by screwing sensor into designated sensor hole or with proper fittings.

NOTICE: Before attaching the RT-50 to the flow meter, note any potential clearance issues.

User must enter in the K-factor for the RT-50 before use. K-factors are found on meter calibration sheet. For detailed instructions refer to programming instructions in this manual. Once the K-factor is entered the unit is ready to read flow.

Product Description

The RT-50 is a Battery-operated flow sensor that shows Rate and Totals on an easy to read LCD display. With a new, user-friendly menu structure, this unit is simple to setup and use. A new feature with the RT-50 is its Bluetooth capabilities. User can do the setup in the palm of their hand and have a second display for checking flow information. The basic function of this display is to read the incoming frequency from the attached sensor and convert it to a flow reading.

Technical Specifications

Flow Meter Compatibility

JV series positive displacement gear meters and TRG, TR and TW turbine meters.

Power

3.6V “C” cell battery, field replaceable; 3-year continuous use estimated average life, depending on options enabled.

Backup Battery

Lithium coin battery 3V. (CR2032)
Stores user data and time when battery is disconnected.

Response Time

25 mS response, frequency dependent.

Temperature Rating

-4 to 140°F (-20 to 60°C) ambient,
175°F (80°C) maximum fluid temp.

Input Options

Inductive and Carrier frequency sensors

Setup Options

- Local display
- Computer connection (cable shown below)
- Mobile app through Bluetooth connection

Battery Replacement

To replace the battery, first open the unit and unplug battery from BAT connector. Be sure to push down on the locking tab which holds the connector in place. Next pull back on the battery bracket and carefully pull battery pack straight out of the unit. Place new battery pack into the unit and plug it into BAT connector. The RT-50 will initialize and power back on. Unit has a small coin cell backup battery that will keep totalizer values saved while main battery is disconnected.

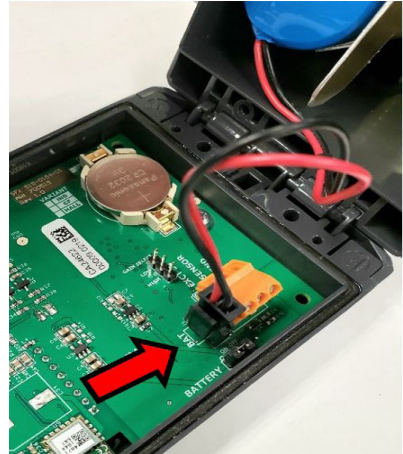

Figure 1: Battery Replacement

Navigational Buttons

Left and Right Arrows

Allows user to switch between flow monitoring displays (ex. Rate, Total, Grand total screen) Also allows user to move left and right when entering values.

Up and Down Arrows

Allows users to move up and down when in the menu structure. Also used to increase and decrease values in programmable fields.

Enter Used to Enter into a selected menu option

F1 (Dynamic button with 2 functions)
-Takes user to Main Menu
-Go Back to previous menu

F2 (Dynamic button with 3 functions)
-Soft Key to go directly into specific menus
-Saves user parameters
-Go Home to Main Screen



Run Mode Screens

There are 5 Run modes screens which include; Logo, Rate, Total, Grand Total, and Bluetooth. To move between screens, simply press the right or left arrow buttons. At the bottom of the run mode screens there are two soft key options, F1 and F2, whose function are noted in [brackets]. F1 gets user to the main programming menu and F2 takes you directly to the parameter you would like to program, such as Rate units or Total units.



Figure 2: Run Mode Screens

Programming Menu Navigation

The programming menu has 5 items. To move between them, use the up and down arrows. To go deeper into the selected Menu, press the **Enter** button.

NOTE: Settings will NOT take effect until user presses Save.

K-Factor

The K-factor is what links the flow display to the meter. Each meter has a specific number of pulses that equals a unit of measure, the RT-50 uses pulses per gallon. In the main menu, press **Enter** on K-Factor (PPG). Using the direction buttons, enter in the k-factor from the calibration sheet in pulses per gallon. The decimal place is fixed. User must move the decimal point over the necessary amount before entering in the number. The right and left arrows move between numbers and the up and down arrows will increase/decrease the number.

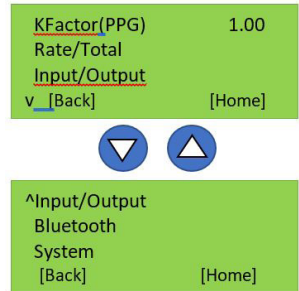

Figure 3

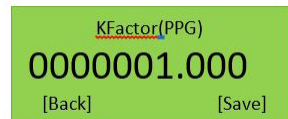

Figure 4

Rate

This menu allows the user to set the units and time base in which they would like to read flow. The Rate and Total are independent of each other and must both be changed if measuring in something other than gallons. With the selection arrow on rate, press the Enter key. Use the up and down arrows to select your units of measure and then press Next (F2). Now select the Time Base in the same way a press Save (F2).

Available units: Pulses, Ounces, Gallons, Barrels, Cubic Centimeters, Cubic Meters, Milliliters, Liters
Available time units: Seconds, Minutes, Hours, Days

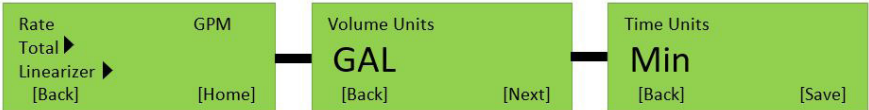

Figure 5

Total

This menu allows the user to set the units in which they would like to read the total and grand total. It is also used to reset the total and grand total. The quick key (F2) on the Total screen takes you directly into the menu to reset the totals. Once you are on the “Volume Units” screen, you will use the up and down arrows to choose desired units and then press Save to store selection.

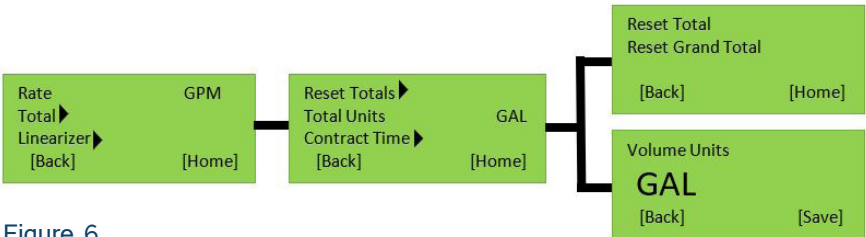

Figure 6

Contract Time

The Contract Time is accessed through the Total menu under Rate/Total. The Contract time allows the user to log totals and grand totals daily. The user will designate a specific time in which they would like the totals to be logged. The user also has the option for the display to automatically reset the total at this time. Along with the Contract Time be sure to set the date and time in the system menu. (see figure 10)

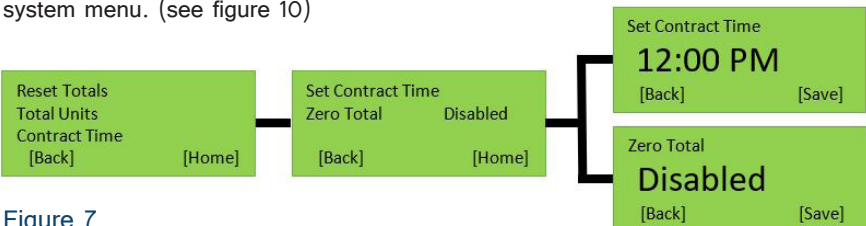

Figure 7

Linearizer

The Linearizer is accessed through the Rate/Total menu. The linearizer is used when the flow meter has different k-factors throughout the flow range. It allows the user to set up to 10 points, each with specific frequencies and k-factors. This feature allows the user to measure more accurately over the full range of the meter. The calibration sheet included with the meter will tell the user what frequencies correlate with each flow rate and the specific k-factor that goes with it. To turn the linearizer On, use the up or down arrow to change Disable to Enabled and press Save. Note that points must be entered in increasing flow rate (frequency) values.

When Linearizer is Active, Single K-Factor is Overridden

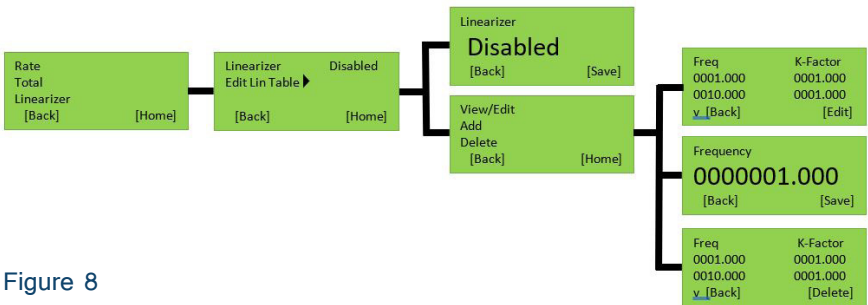

Figure 8

Input/Output

With the battery powered unit, the display only has one option in this menu. It allows the user to set filtering of the displayed flow rate. The filter will help steady the flow rate if it is constantly changing. The options for the filter are; Off, High, Medium, and Low. If the filter is set to Low, it will have the greatest effect on the rate changing (Low response time).



Figure 9

System

In this menu, a user will be able to adjust backlight settings, gate time, and Date/Time. The backlight can be set to stay on for 1–60 seconds or can be turned off completely to save on battery life. The gate time is a feature like the filter, it allows a user to choose the amount of time, in seconds, in which the display will update. For example if the gate time is set to 3 sec, the device will only update the display every 3 seconds. The Date/ Time is where the user can input the current date and time. This is used when the customer is logging totals.

Note: Backlight dramatically decreases battery life

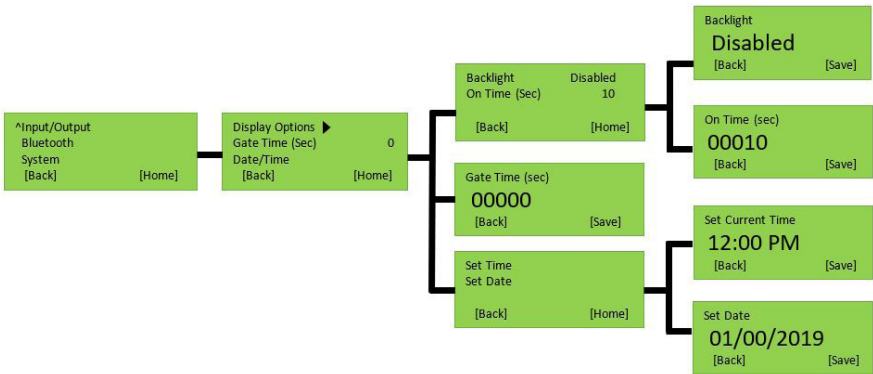

Figure 10

Computer Toolkit

The Toolkit can be used to set up all parameter of the device and view flow rates. This Toolkit also allows the user to update firmware as new releases become available. In order to connect the RT-50 device to the computer a separate cable will need to be purchased from AW-Lake Company. The Toolkit can be found on our webpage under the Downloads tab or by following this link: <https://aw-lake.com/aw-lake-toolkit/>

Connecting

After downloading and opening the software the user will see this connection box appear (Figure 11). First select the correct COM port. If you are unsure which COM port is being used, plug the USB cable in and out of the computer and observe which COM port disappears from the pull-down menu. Next select the device being used or click Auto-Detect Device on COM Port to open the device configuration menu.

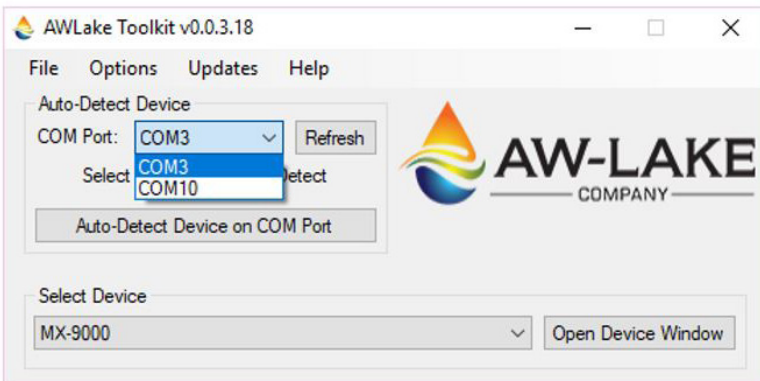

Figure 11

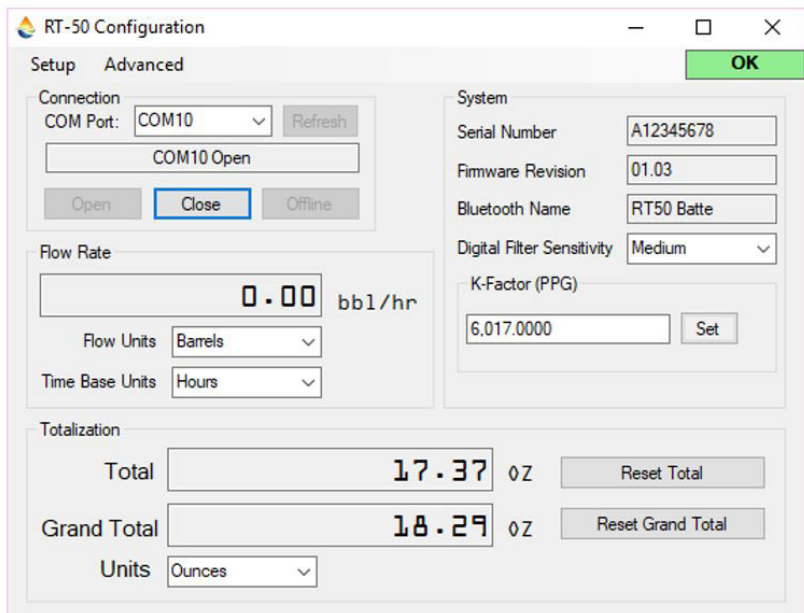

Figure 12

Upgrading Firmware

To upgrade firmware on the device, click the advance tab and select Upgrade Mainboard Firmware. The correct file should automatically be selected. Start Upgrade and wait until complete message appears.



Figure 13



414.574.4300 | www.aw-lake.com
2440 W. Corporate Preserve Dr. #600 Oak Creek, WI 53154