



▶ RT-50 DC/Loop Flow Transmitter

Installation, Operating & Maintenance Manual

Table of Contents

Unpacking	3
Quick Start Guide	3
Power	3
Installation.....	3
Product Description	3
Technical Specifications	4
Part Number Guide	4
Wiring Connections	5
Power Supply	6
Isolated Outputs	6
Analog Outputs.....	7
Navigational Buttons	8
Run Mode Screens	9
Menu Navigation	9
K-Factor	10
Rate	10
Total	10
Contract Time	11
Linearizer.....	11
Input/Output.....	12
System	12
Bluetooth	13
Mobile Bluetooth App	13
Menu Navigation	14
System Settings	15
Output Settings	16
Output Calibration.....	16
Limit Settings.....	17
Linearizer	18
Device Log.....	19
Date/Time Settings	19
Compter Toolkit.....	20
Connecting	20
Updating Firmware.....	21

Unpacking

Separate the RT-50 Flow Display from packaging materials and check for any visual signs of damage. If you determine there are damages caused by shipping, file a claim with the shipping company. If the flow monitor appears to have been improperly assembled or does not operate properly, Contact AW-Lake's returns department for replacement or repair.

Quick Start Guide

CAUTION: As with any precision-engineered device, always use the RT-50 in accordance with the manufacturer's instructions.

Power

Depending on version, the RT-50 can be powered with 24 Volts DC or can be loop powered. Please check model number code to verify version type. For DC, Power can be applied to pins 13 & 14. For Loop, apply power to pins 11 & 12.

See [Page 5](#) for Connection details.

Installation

Secure display to flow meter by screwing sensor into designated sensor hole or with proper fittings.

NOTICE: Before attaching the RT-50 to the flow meter, note any potential clearance issues.

User must enter in the K-factor for the RT-50 before use. K-factors are found on meter calibration sheet. For detailed instructions refer to programming instructions in this manual. Once the K-factor is entered the unit is ready to read flow.

Product Description

The RT-50 flow display has the option to be powered by Battery, Loop, or DC voltage. Showing Rate and Totals on an easy-to-read LCD display. With a new, user-friendly menu structure, this unit is simple to setup and use. A new feature with the RT-50 is, its Bluetooth capabilities. User can do the setup in the palm of their hand and have a second display for checking flow information. The basic function of this display is to read the incoming frequency from the attached sensor and convert it to an accurate flow reading.

Technical Specifications

Ambient Temperature

-4°F to +185°F (-20°C to +85°C)

Supply Voltage Range

24VDC or 4-20mA Loop

Analog Outputs

Lithium coin battery 3V. (CR2032)
4-20mA and 0-5V/1-5V

Limits

2 isolated limit outputs (24VDC Max)

Frequency Output

Isolated output, matches sensor output

Linearizer

10-point programmable linearizer

Communication

Bluetooth and Modbus

Response Time

25 mSec

Housing Rating

NEMA 4X

Part Number Guide

RT-50--

Power

- D = DC powered
- L = Loop powered
- B = Battery powered

Sensor Mounting Thread

- 0 = Special mounting
- 3 = 1/2"-20 UNF (TRG turbines)
- 5 = M14 (gear meters)
- 7 = 1/2" TW collar
- 8 = 3/4" TW collar
- 9 = 1" TW collar

Series

- 1 = TRG turbine and gear meters (-60 & smaller)
- 2 = JV-80KL & -90KL gear meters
- 3 = TW & TR turbine meters
- 4 = High temperature

Sensor Type

- C = Carrier frequency (SS meters, TRG turbines)
- M = Inductive (TR & TW turbine meters)
- N = Inductive (Aluminum meters)

Options Based on Power Supply

	LOOP POWER	DC POWER	BATTERY POWER
BT	✓	✓	✓
BT decoupling	✓		
MODBUS		✓	
Isolated In/Out	✓	✓	
I-OUT sourcing		✓	
I-OUT sinking	✓		
Hall Effect sensor	✓ (only when DC connected)	✓	
RF/IND sensor	✓	✓	✓
V-OUT		✓	
Backlight	✓	✓	✓

Wiring Connections

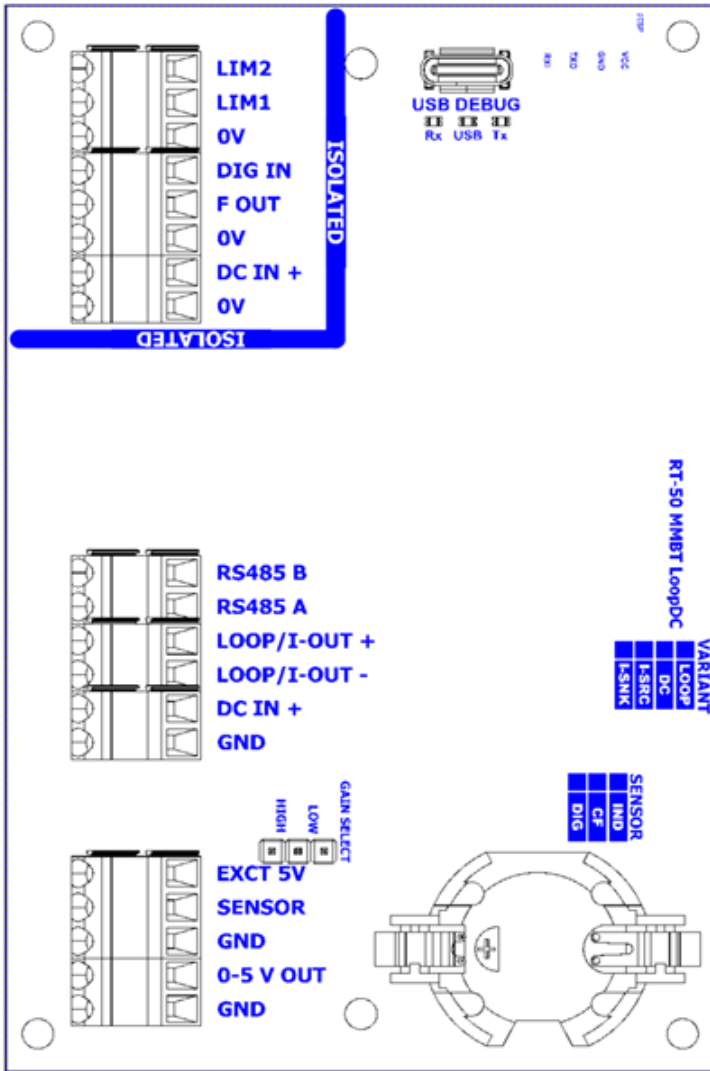

Isolated Outputs

- Limit 2
- Isoltated Limit 1
- 0V
- Digital In
- Frequency Out
- 0V
- DC Voltage Input +
- DC Voltage

Power and Comms

- RS485 B
- RS485 A
- Loop + / I-out +
- Loop - / I-out -
- DC In + (Supply Power +)
- Ground (Supply Power -)

Sensor

- External 5V (Sensor Power +)
- Sensor Input
- Ground (Sensor Ground)
- 0-5 V Output
- Ground (Voltage Out Ground)

Power Supplies (Dependent on Variant)

DC Powered:

Voltage: 12 to 27V DC

Current: < 100mA

Loop Powered:

Voltage: 12 to 27V DC

Current: < 24mA

Isolated Outputs

The Isolated outputs require separate power.

Voltage: 12 to 27V DC

Current: < 10mA

Digital Input:

Input series resistance: 3.3 k Ω

Input Internal Pull-up resistance: 470 k Ω

Input Voltage: 3 – 12V

Input Frequency: < 10kHz

Isolated Input:

Input series resistance: 3.3 k Ω

Input Internal Pull-up resistance: 470 k Ω

Input Voltage: 3 – 12V

Input Frequency: < 10kHz

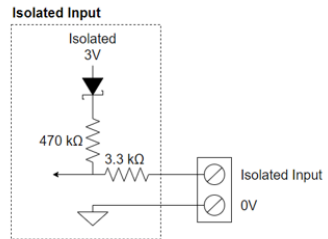

Isolated Output:

Output Configuration: Open Drain

Output Drain Current MAX: 100 mA

Output series resistance MAX: 6 Ω

Output Internal Pull-up resistance: 3.3 k Ω

Output Pull-up voltage: Connected Isolated DC Supply Voltage

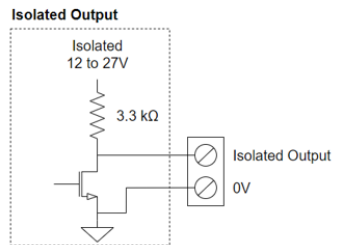

Analog Outputs

Passive 4-20mA (Sinking) and Loop Powered

Loop Compliance Voltage: 12 to 27V

*Note that Loop Return is at different potential to 0V

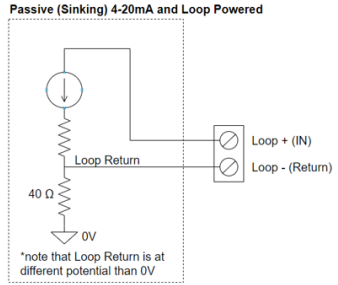

Active 4-20mA (Sourcing) Output:

Voltage on Output Terminal MAX: 12 to 27V (DC Supply voltage)

Output series resistance: 30 Ω

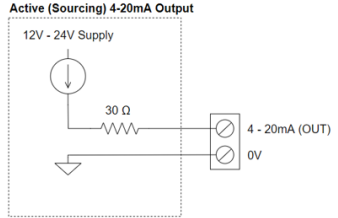

0 - 5V Output:

Output series resistance: 400 Ω

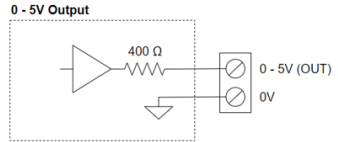

Navigational Buttons



Left & Right Arrows

Allows user to switch between flow monitoring displays (ex. Rate, Total, Grand total screen) Also allows user to move left and right when entering values.

Up & Down Arrows

Allows users to move up and down when in the menu structure. Also used to increase and decrease values in programmable fields.

Enter

Used to Enter into a selected menu option.

F1

Dynamic button with 2 functions

- Gets user into Main Menu
- Go Back to previous menu

F2

Dynamic button with 3 functions.

- Quick Key to go directly into specific menus
- Saves user parameters
- Go Home to Main Screen

Run Mode Screens

There are 7 Run modes screens which include Home, Rate, Total, Grand Total, Analog Out, and Bluetooth. To move from one screen to another simply press the right or left arrow buttons. At the bottom of the run mode screens there are two fast key options, F1 and F2. F1 gets you to the main menu and F2 takes you directly to the programming parameter in the menu.

Note: Loop version does not have a limit screen but limits function the same.



Figure 1

Menu Navigation

The Main menu has 5 items. To move between them, use the up and down arrows. To go into the selected Menu press the Enter button.

Note: settings will not take effect until user presses SAVE

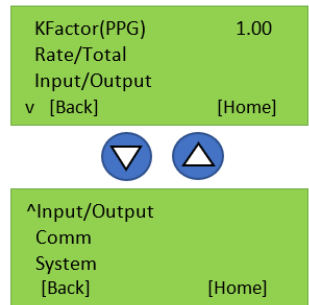

Figure 2

K-Factor

The K-factor is what links the flow display to the meter. Each meter has a specific number of pulses that equals a unit of measure, the RT-50 uses pulses per gallon. In the main menu press Enter on K-Factor (PPG) and using the direction buttons enter in the k-factor from the calibration sheet in pulses per gallon.



Figure 3

The decimal place does not move, so move over the necessary amount before entering in the number. The right and left arrows move between numbers and the up and down arrows will increase/decrease the number.

Rate

This menu allows the user to set the units and time base in which they would like to read flow. The Rate and Total are independent of each other and must both be changed if measuring in something other than gallons. With the selection arrow on rate, press the Enter key. Use the up and down arrows to select your units of measure and then press Next (F2). Now select the Time Base in the same way a press Save (F2).

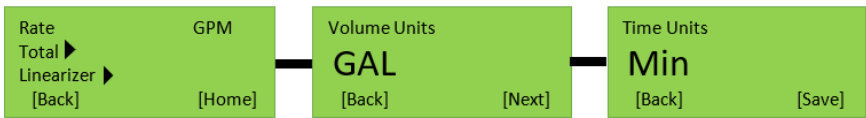

Figure 4

Total

This menu allows the user to set the units in which they would like to read the total and grand total. It is also used to reset the total and grand total. The quick key (F2) on the Total run mode screen takes you directly into the menu to reset the totals. Once in the Volume Unit selection, use the up and down arrows to choose desired units and press Save.

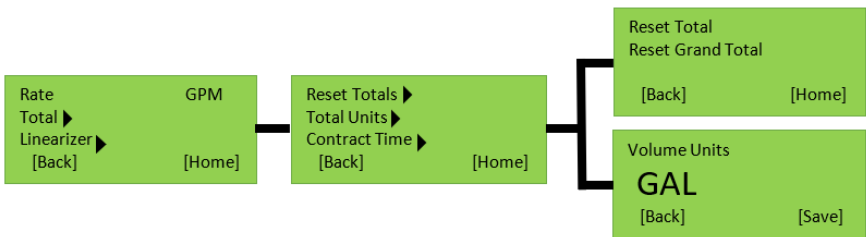

Figure 5

Contract Time

The Contract time allows the user to log totals and grand totals daily. The user will designate a specific time in which they would like the totals to be logged. The user also has the option for the display to automatically reset the total at this time. Along with the Contract Time be sure to set the date and time in the system menu. (see figure 6).

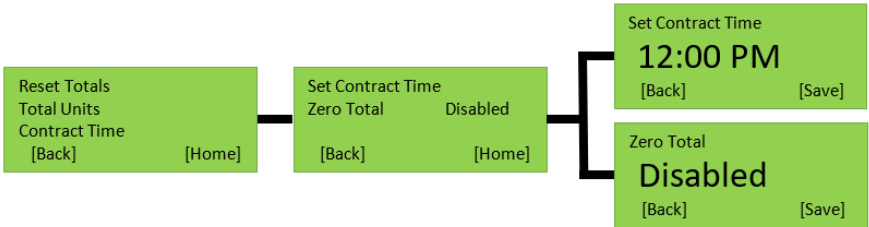

Figure 6

Linearizer

The linearizer is used when the flow meter has different K-factors throughout the flow rate range. It allows the user to set up to 10 points, each with specific frequencies and K-factors. This allows the user to measure more accurately through the whole range. The calibration sheet included with the meter will tell the user what frequencies correlate with each flow rate and the specific K-factor that goes with it. To turn the linearizer On.

Note: For easier setup of the linearizer, users can program the table in the Bluetooth app.

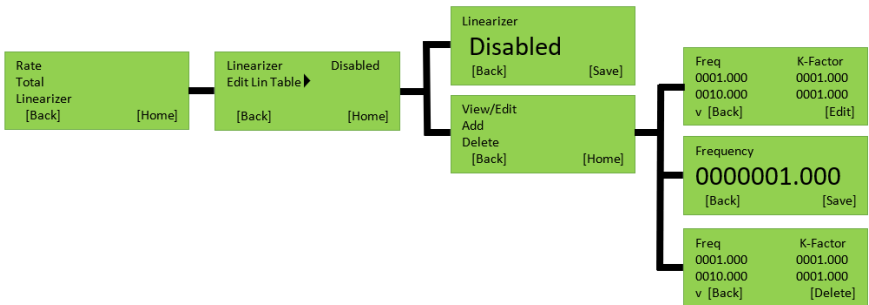

Figure 7

Input/Output

The Loop and DC versions of the RT-50 have 2 isolated limit outputs, 4-20 ma outputs, Voltage Output (DC version only), and an input filter. See page 6 for wiring and circuit specifications.

Limits - Can be set to trigger from a Total, Grand Total, or Rate. When the setpoint is reached the limit will trigger.

Input Filter - Allows the user to set filtering of the displayed flow rate. The filter will steady the flow rate. Options for the filter include Off, High, Medium, and Low. If the filter is set to Low, it will have the greatest effect on the rate changing (Low response time).



Figure 8

System

In this menu, a user will be able to adjust backlight settings, gate time, and Date/Time.

Backlight - Can be set to stay on for a period of time between 1-3600 seconds or can be turned off completely.

Gate Time - A feature similar to the filter, it allows a user to choose the amount of time, in seconds, in which the display will update. For example if the gate time is set to 3 sec, the device will only update the display every 3 seconds.

Date/ Time - User can input the current date and time. This is used when the customer is data logging.

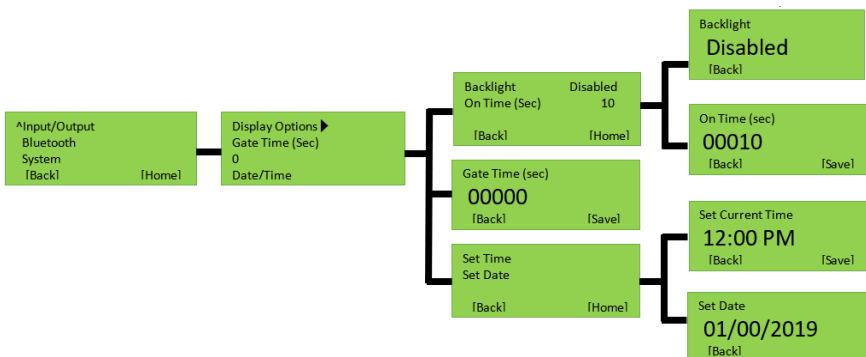

Figure 9

Bluetooth

This device is equipped with Bluetooth, allowing the user to read flow data and set up the device via a mobile app. The Bluetooth menu is where a user can turn Bluetooth connectivity on and off. It is also where a user changes the Bluetooth name. Bluetooth is defaulted to enabled but is not always in pairing mode. To put the device in pairing mode a user can press the Enter button on the Bluetooth run mode screen (Figure 10) or in the Bluetooth menu under Pair BT. To disable Bluetooth, press Enter on Bluetooth, press down to select disable, and press the Save button.

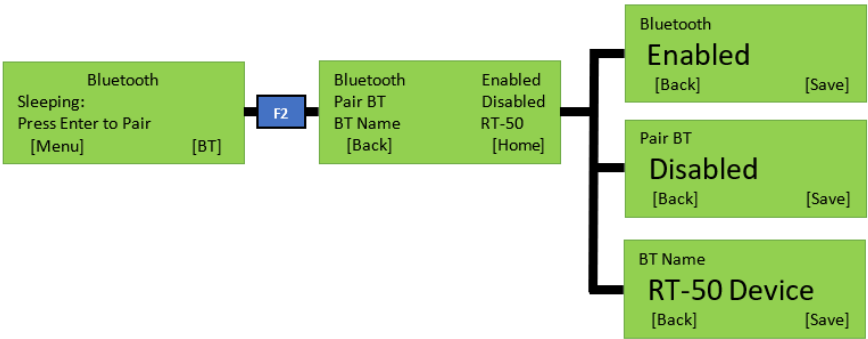

Figure 10

Mobile Bluetooth App

First download the free app from the apple or google play store. Before connecting to the RT-50, the user must navigate to the Bluetooth screen on the device and enable pairing mode. This is done by hitting Enter. User will then have 5 minutes to connect to the device. Open the app, turn on Bluetooth, and press Next button to scan for available devices. Once found, tap on the desired device which will take the user to the device's main menu. If a device is not found, a user can scan again by sliding their finger down from the top of the screen.

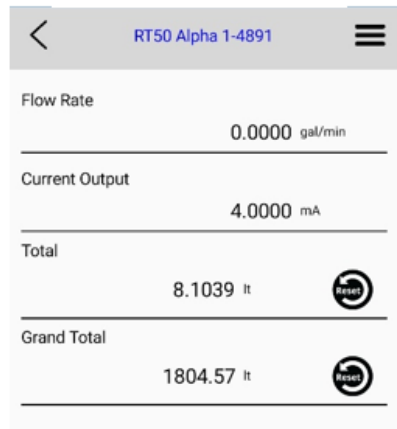

Figure 11

***Location must be allowed to find a Device**

Menu Navigation

Press the three lines in the top right corner to access menu

System Settings: Adjust K-factor, Max Flow Rate, Filter, Time Base, Flow Units, and Bluetooth name

Output Setting: Allows user to change Analog Outputs and Force a specific analog output.

Output Calibration: Allows user to slightly adjust analog outputs to better match the system.

Limits: Allows user to set up limits to trigger by events related to rate, total, and grand total.

Linearizer Table: Allows user to select custom K-factors for changing flow rates

Diagnostics: Shows raw input frequency

Device Log: Shows daily Total and Grand Total

Date/Time Settings: Allows user to set real time and date

Display Settings: Allows user change backlight settings and Gate time

About Bluetooth Device: Displays device information

Factory Reset: Resets all user parameters to default

Disconnect: Used to disconnect from device

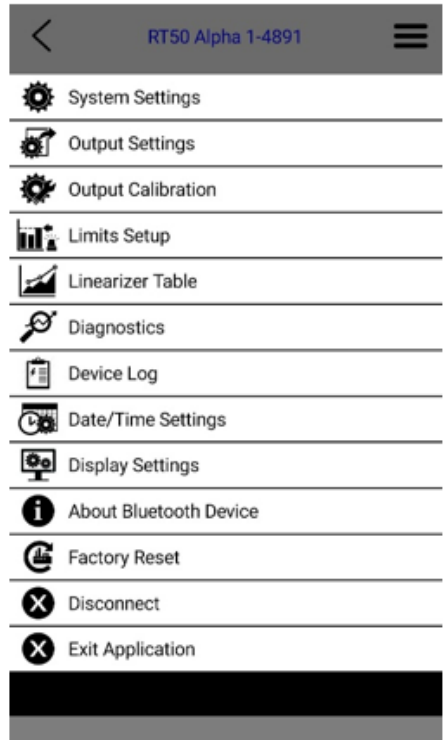

Figure 12

System Settings

This menu allows users to scale the RT-50 to display correct flow rate in the desired units and time base. It will also allow for filtering of the output.

After any option is changed press SET for it to take effect. Use back button on phone to return to main screen.

- **K-Factor:** is the flow meter scaling factor in pulses/volume (found on calibration sheet)
- **Digital Filter:** Will smooth out erratic input frequency. There are four options to choose from;
 - **Off:** No filtering
 - **Low:** Most filtered, low sensitivity. (Corner frequency $\frac{1}{4}$ Hz)
 - **Medium:** Medium sensitivity. (Corner frequency 1 Hz)
 - **High:** least filtered, High sensitivity. (Corner frequency 10 Hz)
- **Flow Time Base:** Can be set to Sec, Min, Hours, and Days.
- **Flow Units:** Selects what unit to measure flow in. Available units include; Pulses, Ounces, Gallons, Barrels, Cubic Centimeters, Cubic Meters, Milliliters, Liters
- **Total Units:** Selects what unit to measure flow in. Available units include; Pulses, Ounces, Gallons, Barrels, Cubic Centimeters, Cubic Meters, Milliliters, Liters
- **Bluetooth Name:** is the name that will appear when searching for the device. Connection will be lost after changing the Bluetooth name and will require reconnection. Device is limited to 12 characters. If more than 12 characters are entered it could cause connectivity issues with the device.

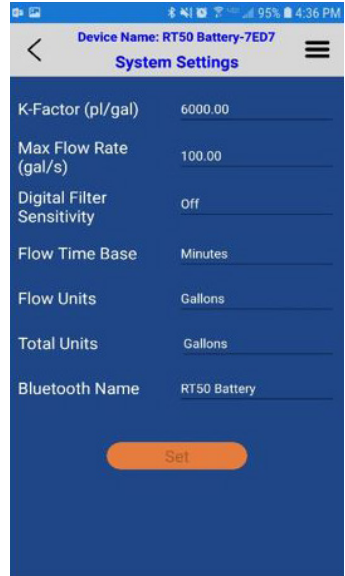

Figure 13

Output Settings

Forced Outputs:

This menu will provide the option to force one or both outputs to a certain value. Along with this ability, Voltage output type will also be selectable. (Figure 14) To activate, Move the slider to the right. Enter in desired forced output and press SET to store information.

**Note: Forced output will not output a value when only being powered by USB. Information will not be stored until SET is pressed and forced value will revert back to previous value or state if output value is outside of the range.*

Forced Output Limitations:

When forcing an output, it must be in between the analog out specifications and will go to the third decimal place.

Ex. 4-20mA output Forced output: 6.25mA

Output Calibration

WARNING: *Modifying these outputs could result in inaccurate analog signals.*

This menu is provided to adjust the EDGE analog output to correspond correctly with the analog output of the input device.

** This menu is intended for use with slight output differences between the EDGE output and customer input device. These values are factory calibrated before shipping to match meters that are calibrated annually.*

Select Calibration Type: From this menu both mA and Voltage outputs may be calibrated. (Figure 15)

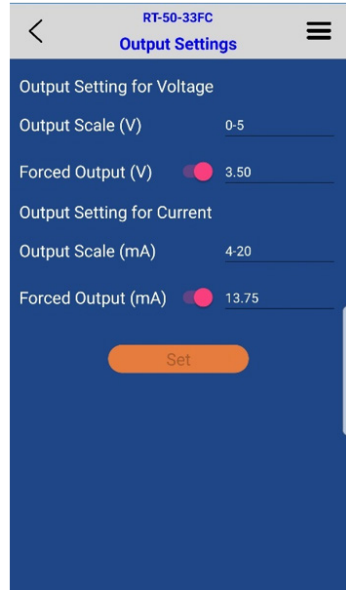

Figure 14

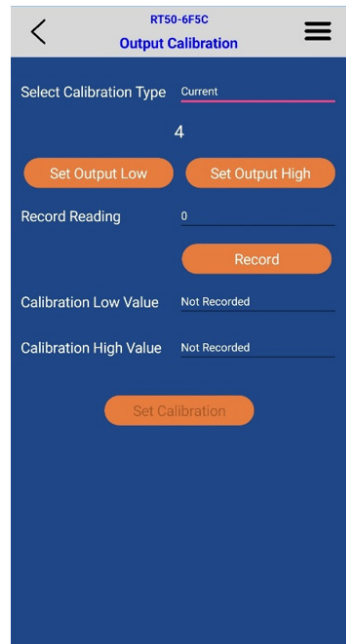

Figure 15

1. Select which output type to be calibrated; mA or Voltage
2. Press Set Output Low, then enter in the value on user's device into **Record Reading**
 - a. Ex. If EDGE is being calibrated to a multimeter, enter reading from multimeter to **Record Reading**
3. Press **Record** button
4. Now press **Set Output High** to calibrate the high end of the output
5. Enter in High reading from input device to **Record Reading**
6. Press **Record** button
7. Verify both Calibration high and low values are correct and press **Set Calibration**
8. Use back button on phone to navigate to the main menu

**Warning do not do 2 calibrations in a row. After calibration is finished, exit the app and restart the device.*

Limits

The limit screen is used to set the parameters that trigger the outputs. To use this function, set the Input Source on the Output Settings menu to Limit. The limit has 4 types of triggers: Rate, Total, Grand Total, and Cycle Output.

Rate – Output will go high when flow rate is within the given parameters and low when it goes outside. Select a threshold/ target rate, then select the percentage the flow rate that is allowed to drift from that threshold. Example: a 10% bound on a threshold of 20 gpm would give a rate range of 18–22 gpm.

Total – Output will go high when Total goes above the threshold value.

Grand Total – Output will go high when Grand Total goes above the threshold value.

Cycle Output – Output will change state between high and low every time the threshold total is reached. To achieve one pulse per desired output, divide that value by 2. For example, to get 1 pulse per gallon set threshold to 0.5 gallons.

Cycle Output limited to 5Hz or 300 pulses per minute

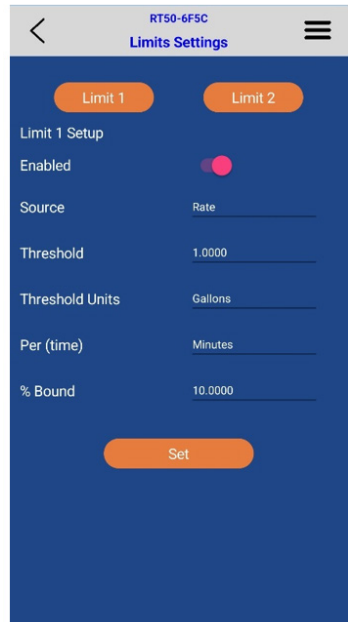

Figure 16

Linearizer

The linearizer function is designed to correct for devices that will vary in a nonlinear way as a device changes in flow/frequency. It can take nonlinear input and change it to a more linear analog output. There is a maximum of 10 points that can be entered.

Ex. Looking at a meter that has a range of 0.5–2 GPM. If at 0.5 GPM (=100HZ) it has a K-factor of 1800, at 1.5 GPM (=200Hz) it has a K-factor of 1850, and at 2.0 GPM (=300Hz) it has a K-factor of 1900. Using a linearizer would ensure the most accurate results over the full range of flow.

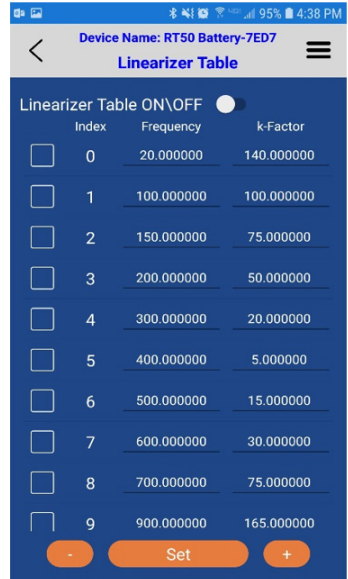

Figure 17

Entering Values:

Values may only be entered and changed when Linearizer is Off

Adding Values:

To enter in new values to the linearizer, press the “+” button at the bottom of the screen. This will bring up a new window that prompts the user to type in a desired frequency and corresponding K-factor. After values are entered, press Add, this will input them into the table. If more values are needed, repeat this step.

Editing Values:

To edit a value already in the table. Press on the value that needs changing and enter in the new value. Do this for all existing numbers that need updating. To save changed values press the Set button

Deleting Values:

To delete values in the table. Press the empty square next to the Index number. This will be filled with a checkmark. Once all desired table values are selected, press the “-” button, at the bottom of the screen, to remove the selected table values.

Device Log

This menu is used in correspondence with the Contract time located in the Date/Time menu. A user can set a designated contract time, and at this designated time the unit will save the Total and Grand total in a table.

This menu allows the user to view those results. The log will hold 29 values before it starts to overwrite oldest entry. User will be able to copy these values with a button on the screen and paste it in other documents on their phone.

Note: When a factory reset is performed, log values will be deleted

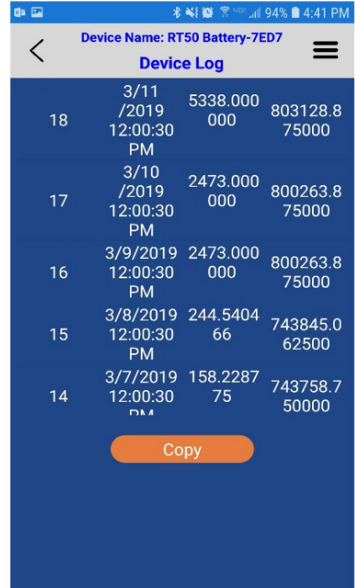

Figure 18

Date/Time Settings

The Date and Time menu lets the user edit the current date and time into the device. It allows the user to enter in a Contract time, which is the time at which the unit will record totals into the device log. Remember to press the Set button to update all changes made. There is also an option to reset the Total at this designated time. This will only reset the Total and not the Grand Total.

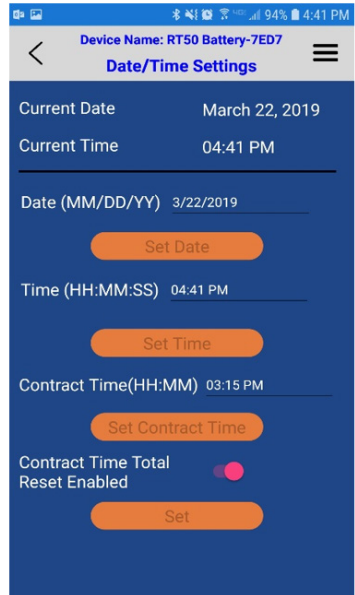

Figure 19

Computer Toolkit

The Toolkit can be used to set up all parameter of the device and view flow rates. This Toolkit also allows the user to update firmware as new releases become available. In order to connect the RT-50 device to the computer a separate cable will need to be purchased from AW-Lake Company. The Toolkit can be found on our webpage under the Downloads tab or by following this link: <https://aw-lake.com/aw-lake-toolkit/>

Connecting

After downloading and opening the software the user will see this connection box appear (Figure 19). First select the correct COM port. If you are unsure which COM port is being used, plug the USB cable in and out of the computer and observe which COM port disappears from the pull-down menu. Next select the device being used or click Auto-Detect Device on COM Port to open the device configuration menu.

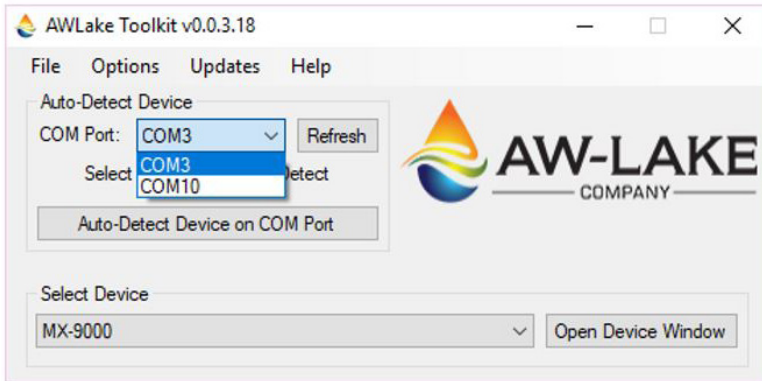

Figure 19

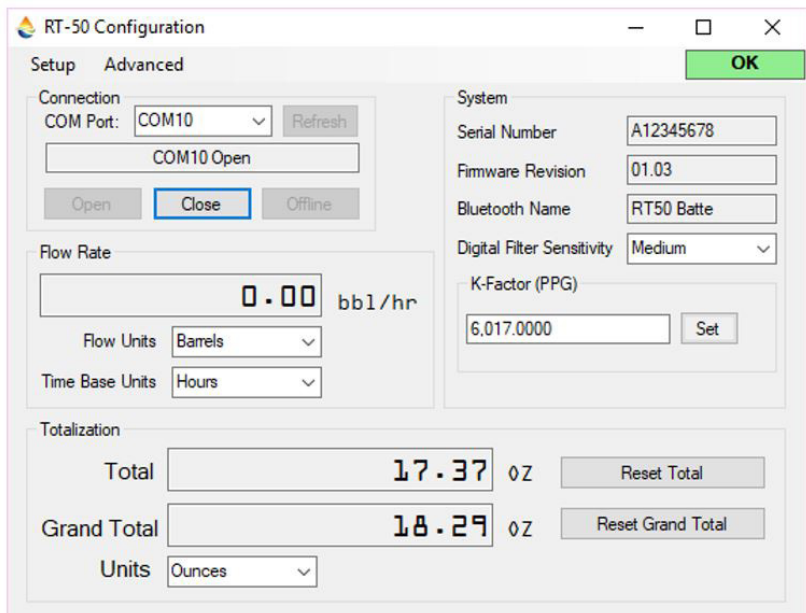

Figure 20

Upgrading Firmware

To upgrade firmware on the device, click the advance tab and select Upgrade Mainboard Firmware. The correct file should automatically be selected. Start Upgrade and wait until complete message appears.



Figure 21



414.574.4300 | www.aw-lake.com
2440 W. Corporate Preserve Dr. #600 Oak Creek, WI 53154