



TRICOR®

Coriolis Mass Flow Meter with TCD 9000 electronics





Manual-Version

TCMQ_E90_PRO_Plus_M_EN_190730_E009

This document is supplied as standard in electronic media with the device. Latest version can be downloaded at www.tricorflow.com.

NOTE:

This manual applies to the Coriolis Flow Meter with the brand TRICOR.

Index

- 1. INTRODUCTION 7**
 - 1.1. Purpose of this Documentation 7
 - 1.2. Product Compatibility 7
 - 1.3. Items Supplied 8
 - 1.4. Checking the Consignment 9
 - 1.5. Security Information 9
 - 1.6. Transportation and Storage 9
- 2. SAFETY NOTES 10**
 - 2.1. Preconditions for Use 10
 - 2.2. Laws and Directives 10
 - 2.2.1. FCC Conformity 11
 - 2.2.2. Conformity with European Directives 11
 - 2.3. Requirements for Special Applications 12
 - 2.4. Use in Hazardous Areas 12
 - 2.4.1. Special Conditions for Safe Use TCD 9010/9100 electronics 13
 - 2.4.2. Special Conditions for Safe Use TCD 9200 electronics (wall mount) 14
 - 2.4.3. Installation in Hazardous Areas 14
- 3. DESCRIPTION 18**
 - 3.1. Design 18
 - 3.2. Ordering Codes and Accessories 21
 - 3.2.1. Ordering Code 21
 - 3.2.2. Process Connection and Installation Length in mm [inch] 22
 - 3.2.3. Accessories 23
 - 3.3. Features 23
 - 3.4. Applications 25
 - 3.5. Approvals 25
 - 3.6. Theory of Operation 25
- 4. INSTALLING/MOUNTING 27**
 - 4.1. Basic Safety Notes 27
 - 4.1.1. Note 27
 - 4.1.2. Installation Location Requirements 28
 - 4.1.3. Proper Mounting 29
 - 4.2. Installation Instructions 30
 - 4.2.1. Transmitter Installation 30
 - 4.2.2. Sensor Installation 33
 - 4.3. Disassembly 39



5.	ELECTRICAL INSTALLATION	40
5.1.	Basic Safety Notes.....	40
5.2.	Connecting the Transmitter.....	44
5.2.1.	Cable Requirements.....	44
5.2.2.	Transmitter Power Supply and I/Os Connection	45
5.3.	Wiring Information	57
5.3.1.	Wiring in Hazardous Areas.....	57
5.4.	Device Nameplates	58
5.4.1.	Device Identification	58
6.	COMMISSIONING	63
6.1.	Basic Safety Notes.....	63
6.1.1.	Warnings	64
6.2.	General Requirements.....	64
6.3.	Commissioning Assistants.....	65
6.3.1.	Operation of the display/HMI	65
6.3.2.	Commissioning via HMI.....	66
6.3.3.	Power-up.....	78
7.	OPERATING DISPLAY	79
7.1.	Operating Instructions.....	79
7.1.1.	Local Display (HMI).....	79
8.	FUNCTIONS	99
8.1.	Process Values	99
8.1.1.	Process Value Parameters.....	99
8.1.2.	Limits and Hysteresis.....	99
8.1.3.	Process Value Derivations.....	101
8.2.	Zero Point Adjustment.....	102
8.3.	Low Flow Cut-Off	103
8.4.	Empty Tube Monitoring.....	103
8.5.	Process Noise Damping	104
8.6.	Inputs and Outputs.....	106
8.6.1.	Current Output.....	107
8.6.2.	Pulse Output	112
8.6.3.	Frequency Output	112
8.6.4.	Redundancy Mode (frequency)	113
8.6.5.	Redundancy Mode (pulse)	114
8.6.6.	Digital Output.....	115
8.6.7.	Input	115
8.7.	Totalizers.....	116
8.7.1.	Totalizer Functions.....	116
8.8.	Dosing	116
8.8.1.	Dosing Control Configuration.....	118
8.8.2.	Valve Control Configuration.....	118
8.8.3.	Dosing Operation	124
8.8.4.	Fault Handling	124
8.9.	Audit Trail Logging	124

8.10.	Diagnostic Log.....	125
8.11.	Custom Unit.....	125
8.12.	SD-Card	125
8.13.	Datalogging on the SD-Card.....	126
8.14.	Process Peak Values on SD-Card.....	126
8.15.	Simulation.....	126
8.16.	Maintenance.....	127
9.	SERVICE AND MAINTENANCE	128
9.1.	Basic Safety Notes.....	128
9.2.	Recalibration.....	129
9.3.	Cleaning	129
9.4.	Maintenance and Repair Work.....	129
9.4.1.	Service Information.....	132
9.5.	Replacing the Device.....	132
9.6.	Return Procedure	132
9.7.	Disposal.....	133
10.	DIAGNOSING AND TROUBLESHOOTING	134
10.1.	Device Status Symbols	134
10.2.	Fault Codes and Corrective Actions.....	136
10.2.1.	Sensor Diagnostic Events	136
10.2.2.	Transmitter Diagnostic Events	140
10.3.	Operation Troubleshooting	152
10.3.1.	How do I copy application setup from one device to another?	152
10.3.2.	Troubleshooting Sensor-related Problems	152
10.3.3.	How do I update the firmware?.....	156
11.	TECHNICAL DATA	157
11.1.	Power.....	157
11.2.	Performance	158
11.3.	Interface.....	158
11.3.1.	Modbus Interface.....	158
11.3.2.	HART Interface	159
11.4.	Inputs.....	159
11.5.	Outputs.....	159
11.6.	Construction	161
11.6.1.	Sensor Design.....	162
11.6.2.	Cables and Cable Entries.....	163
11.7.	Operating Conditions.....	165
11.8.	Process Variables	166
11.9.	Bus Communication.....	166
11.10.	SD-Card	166
11.11.	PED (European Directive for pressure equipment)	167
11.11.1.	Division of media (liquid/gaseous) into the fluid groups.....	167
11.11.2.	Conformity assessment.....	168

11.11.3. Diagrams	168
11.12. Pressure – temperature ratings.....	170
11.13. Sensor Dimensions	175
11.14. Transmitter Dimensions	175
11.15. Certificates.....	177
12. LISTINGS	179
12.1. Warranty.....	179
12.2. Certificates and Support	179
12.2.1. Technical Support.....	179
12.2.2. Certificates	179
12.3. WEEE and RoHS	179
12.4. Menu Structure.....	180
12.4.1. Main Menu.....	180
12.4.2. Menu Item “Sensor” (2.1).....	182
12.4.3. Menu Item “Process values” (2.2)	183
12.4.4. Menu Item “Totalizer” (2.3).....	186
12.4.5. Menu Item “Inputs and outputs” (2.4)	187
12.4.6. Menu Item „Dosing“ (2.5).....	193
12.4.7. Menu Item „Date and time“ (2.7).....	198
12.4.8. Menu Item „Display“ (2.8)	198
12.4.9. Menu Item „Identification“ (3.1)	200
12.4.10. Menu Item "Diagnostic events" (3.2).....	201
12.4.11. Menu item "Maintenance" (3.3).....	202
12.4.12. Menu item "Diagnostic" (3.4)	203
12.4.13. Menu item "Peak values" (3.5)	204
12.4.14. Menu item "Characteristics" (3.6)	205
12.4.15. Menu item "SD-Card" (3.7)	206
12.4.16. Menu item "Simulation" (3.8).....	207
12.4.17. Menu item "Audit trail" (3.9)	208
12.4.18. Menu item "Self test" (3.10)	208
12.4.19. Menu item "Resets" (3.11).....	208
12.4.20. Menu item "Firmware update" (3.12)	208
12.4.21. Menu item "Communication" (4)	209
12.4.22. Menu item "Security" (5)	210
12.5. List of Figures.....	211
12.6. List of Tables	213
12.7. Subject Catalog	216



1. Introduction

1.1. Purpose of this Documentation

These instructions contain all information required to commission and use the device. Read the instructions carefully prior to installation and commissioning. In order to use the device correctly, first review its principle of operation.

The instructions are aimed at persons mechanically installing the device, connecting it electronically, configuring the parameters and commissioning it, as well as service and maintenance engineers.

Use the device to measure process medium in accordance with the information in the Operating Instructions.

NOTE

Use in a domestic environment

This Class A Group 1 equipment is intended for use in industrial areas.

In a domestic environment this device may cause radio interference.

1.2. Product Compatibility

Edition	Remarks	Product compatibility	Compatibility of device integration package
07/2019	First revision	HW revision 03 Compact FW revision 4.00.01-29	Modbus: V8.2 Service Pack 1 or later HART: V8.2 Service Pack 1 or later HART: DTM V4.1 HART: AMS Device manager V12 PROFIBUS: V8.2 Service Pack 1 or later PROFIBUS: AMS Device manager V12 PROFIBUS: DTM V4.1

Tab. 1: Product compatibility



1.3. Items Supplied

The device can be delivered as either a compact or a remote system.

Compact system (optional without display)

- Coriolis sensor and compact mounted transmitter
- Data storage medium containing certificates and device manuals



Fig. 1: Compact version

Wall mount version

Remote display electronics

- Coriolis sensor
- TCD 9200 transmitter with M12 socket assembled
- Mounting bracket and cushion pad
- Sensor cable
- Data storage medium containing certificates and device manuals



Fig. 2: Remote version

NOTE:

Supplementary information

Supplementary product and production specific certificates are included on the SD card in the transmitter socket (does not apply to TCD 9010 transmitter).

NOTE:

Scope of delivery may vary, depending on version and add-ons. Make sure the scope of delivery and the information on the nameplate correspond to your order and the delivery note.



1.4. Checking the Consignment

1. Check the packaging and the delivered items for visible damage.
2. Report any claims for damages immediately to the shipping company.
3. Retain damaged parts for clarification.
4. Check the scope of delivery by comparing your order to the shipping documents for correctness and completeness.

WARNING!

Using a damaged or incomplete device

Risk of explosion in hazardous areas.

Do not use damaged or incomplete devices.

1.5. Security Information

TRICOR provides products and solutions with industrial security functions that support the secure operation of plants, systems, machines, and networks.

In order to protect plants, systems, machines and networks against cyber threats, it is necessary to implement – and continuously maintain – a holistic, state-of-the-art industrial security concept. TRICOR products are only one element of such a concept.

Customer is responsible to prevent unauthorized access to its plants, systems, machines and networks. Systems, machines and components should only be connected to the enterprise network. Appropriate security measures (e.g. use of firewalls and network segmentation) should be in place.

TRICOR products and solutions undergo continuous development to make them more secure. It is strongly recommended to apply product updates as soon as available and to always use the latest product versions. Use of product versions that are no longer supported, and failure to apply latest updates may increase customer's exposure to cyber threats.

1.6. Transportation and Storage

To guarantee sufficient protection during transport and storage, observe the following:

- Keep the original packaging for subsequent transportation.
- Devices/replacement parts should be returned in their original packaging.
- If the original packaging is no longer available, ensure that all shipments are properly packaged to provide sufficient protection during transport. TRICOR cannot assume liability for any costs associated with transportation damages.

NOTE:

Insufficient protection during storage

The packaging only provides limited protection against moisture and infiltration.

Provide additional packaging as necessary.

Special conditions for storage and transportation of the device are listed in “Technical Data” (chapter 11, page 157).

2. Safety Notes

2.1. Preconditions for Use

This device left the factory in good working condition. In order to maintain this status and to ensure safe operation of the device, observe these instructions and all the specifications relevant to safety.

Observe the information and symbols on the device. Do not remove any information or symbols from the device. Always keep the information and symbols in a completely legible state.

Symbol	Explanation
	Consult operating instructions

Use the device only for flow measurement in accordance with this operating instruction and observe the technical data.

WARNING!

Improper device modifications

Risk to personnel, system and environment can result from modifications to the device, particularly in hazardous areas.

Only carry out modifications that are described in the instructions for the device. Failure to observe this requirement cancels the manufacturer's warranty and the product approvals.

2.2. Laws and Directives

Observe the safety rules, provisions and laws applicable in your country during connection, assembly and operation. These include, for example:

- National Electrical Code (NEC - NFPA 70) (USA)
- Canadian Electrical Code (CEC) (Canada)

Further provisions for hazardous area applications are for example:

- IEC 60079-14 (international)
- EN 60079-14 (EC)



2.2.1. FCC Conformity

US Installations only: Federal Communications Commission (FCC) rules

WARNING!

Improper device modifications

Danger to personnel, system and environment can result from improper modifications to the device.

Changes or modifications not expressly approved by TRICOR could void the user’s authority to operate the equipment.

NOTE:

This equipment has been tested and found to comply with the limits for a Class A digital device, pursuant to Part 15 of the FCC Rules. These limits are designed to provide reasonable protection against harmful interference when the equipment is operated in a commercial environment.

This equipment generates, uses, and can radiate radio frequency energy and, if not installed and used in accordance with the operating instructions, may cause harmful interference to radio communications. Operation of this equipment in a residential area is likely to cause harmful interference to radio communications, in which case the user will be required to correct the interference at his own expense.

2.2.2. Conformity with European Directives

The CE marking on the device symbolizes the conformity with the following European directives:

Electromagnetic compatibility EMC 2014/30/EU	Directive of the European Parliament and of the Council on the harmonisation of the laws of the Member States relating to electromagnetic compatibility
Low voltage directive LVD 2014/35/EU	Directive of the European Parliament and of the Council on the harmonisation of the laws of the Member States relating to the making available on the market of electrical equipment designed for use within certain voltage limits
Explosive atmosphere ATEX 2014/34/EU	Directive of the European Parliament and the Council on the harmonisation of the laws of the Member States relating to equipment and protective systems intended for use in potentially explosive atmospheres (depending on version)
Pressure equipment directive PED 2014/68/EU	Directive of the European Parliament and of the Council on the approximation of the laws of the Member States concerning pressure equipment

The applicable directives can be found in the EC conformity declaration of the specific device.

NOTE:

CE declaration

The CE declaration certificate is available on the SD-Card delivered with the device. Alternatively it can be downloaded from the website www.tricorflow.com



2.3. Requirements for Special Applications

Due to the large number of possible applications, each detail of the described device versions for each possible scenario during commissioning, operation, maintenance or operation in systems cannot be considered in the instructions. If you need additional information not covered by these instructions, contact your local TRICOR representative.

NOTE:

Operation under special ambient conditions

We highly recommend that you contact your TRICOR representative or the application department before you operate the device under special ambient conditions as can be encountered in nuclear power plants or when the device is used for research and development purposes.

2.4. Use in Hazardous Areas

Qualified personnel for hazardous area applications

Persons who install, connect, commission, operate, and service the device in a hazardous area must have the following specific qualifications:

- They are authorized, trained or instructed in operating and maintaining devices and systems according to the safety regulations for electrical circuits, high pressures, aggressive, and hazardous media.
- They are authorized, trained, or instructed in carrying out work on electrical circuits for hazardous systems.
- They are trained or instructed in maintenance and use of appropriate safety equipment according to the pertinent safety regulations.

WARNING!

Use in hazardous areas

Risk of explosion

Only use equipment that is approved for use in the intended hazardous area and labelled accordingly.

WARNING!

Loss of safety of device with type of protection "Intrinsic safety Ex i"

If the device has already been operated in non-intrinsically safe circuits or the electrical specifications have not been observed, the safety of the device is no longer ensured for use in hazardous areas. There is a risk of explosion.

Connect the device with type of protection "Intrinsic safety" solely to an intrinsically safe circuit.

Observe the specifications for the electrical data on the certificate and/or in "Technical Data" (chapter 11, page 157).



2.4.1. Special Conditions for Safe Use TCD 9010/9100 electronics

Special conditions for safe use

In general, it is required that:

- The transmitter electronic compartment shall not be opened when energized and when an explosive gas atmosphere may be present.
- The terminal compartment may be opened when an explosive gas or dust atmosphere may be present at any time; access power terminals by lifting the cover only when de-energized.
- Appropriate cable connectors are used.
- The replacement of components is not permitted and impairs Intrinsic Safety.
- Sensor and transmitter are connected to the potential equalization throughout the hazardous area.
- EN/IEC 60079-14 is considered for installation in hazardous areas.

Further information and instructions including approval-specific special conditions for safe use in Ex applications can be found in the certificates on the accompanying data storage medium and at the product web page www.tricorflow.com.

WARNING!

Laying of cables

Explosion hazard

Cable for use in hazardous areas must satisfy the requirements for having a proof voltage of at least 500 V AC applied between the conductor/ground, conductor/shield and shield/ground.

Connect the devices that are operated in hazardous areas as per the stipulations applicable in the country of operation.

WARNING!

Field wiring installation

Ensure that the national requirements of the country in which the devices are installed are met.

WARNING!

Signal wiring

Input/output connections to the transmitter are required to be protected by intrinsic safe barriers at all times.

WARNING!

Improper device modifications

Risk to personnel, system and environment can result from modifications to the device, particularly in hazardous areas.

Only carry out modifications that are described in the instructions for the device. Failure to observe this requirement cancels the manufacturer's warranty and the product approvals.

2.4.2. Special Conditions for Safe Use TCD 9200 electronics (wall mount)

Special conditions for safe use

In general, it is required that:

- The terminal space may be opened when an explosive gas atmosphere may be present at any time; access power terminals by lifting the cover only when de-energized.
- Appropriate cable connectors are used.
- The replacement of components is not permitted and impairs Intrinsic Safety.
- Sensor and transmitter are connected to the potential equalization throughout the hazardous area.
- EN/IEC 60079-14 is considered for installation in hazardous areas.

Further information and instructions including approval-specific special conditions for safe use in Ex applications can be found in the certificates on the accompanying data storage medium and at the product web page www.tricorflow.com.

WARNING!

Laying of cables

Risk of explosion in hazardous areas.

Cable for use in hazardous areas must satisfy the requirements for having a proof voltage of at least 500 V AC applied between the conductor/ground, conductor/shield and shield/ground.

Connect the devices that are operated in hazardous areas as per the stipulations applicable in the country of operation.

WARNING!

Field wiring installation

Risk of explosion in hazardous areas.

Ensure that the national requirements of the country in which the devices are installed are met.

WARNING!

Improper device modifications

Risk to personnel, system and environment can result from modifications to the device, particularly in hazardous areas.

Only carry out modifications that are described in the instructions for the device. Failure to observe this requirement cancels the manufacturer's warranty and the product approvals.

2.4.3. Installation in Hazardous Areas

WARNING!

Equipment used in hazardous areas

Equipment used in hazardous areas must be Ex-approved for the region of installation and marked accordingly. It is required that the special conditions for safe use provided in the manual and in the Ex certificate are followed!



Hazardous area approvals

Special conditions for safe installation and operation specified by each approval authority are included in the relevant certificate.

Standards and a detailed description of the specification and the certificate can be found in an separate TRICOR TCMQ Ex certificate manual.

For related approvals please contact TRICOR sales and support.

2.4.3.1. Specific conditions of use for TCMQ with TCD 9010 Transmitter

- The apparatus housing shall be connected to the potential equalising conductor in the hazardous area.
- The maximum allowable process fluid temperatures with respect to temperature class for the device when used with potentially explosive gases in the following maximum ambient temperatures are:

Max. ambient temperature	Maximum process temperature per temperature class			
	T6	T5	T4	T3
60 °C [140 °F]	70 °C [158 °F]	70 °C [158 °F]	70 °C [158 °F]	70 °C [158 °F]
55 °C [131 °F]	85 °C [185 °F]	100 °C [212 °F]	100 °C [212 °F]	100 °C [212 °F]
50 °C [122 °F]	85 °C [185 °F]	100 °C [212 °F]	130 °C [266 °F]	130 °C [266 °F]
45 °C [113 °F]	85 °C [185 °F]	100 °C [212 °F]	135 °C [275 °F]	160 °C [320 °F]
40 °C [104 °F]	85 °C [185 °F]	100 °C [212 °F]	135 °C [275 °F]	190 °C [374 °F]
35 °C [95 °F]	85 °C [185 °F]	100 °C [212 °F]	135 °C [275 °F]	200 °C [392 °F]
30 °C [86 °F]	85 °C [185 °F]	100 °C [212 °F]	135 °C [275 °F]	200 °C [392 °F]

Tab. 2: Maximum process temperature per temperature class for TCD 9010 transmitter

- The maximum allowable process fluid temperatures with respect to maximum surface temperatures for hazardous dusts for the device when used with hazardous dusts in the following maximum ambient temperatures are:

"Da" application and 500 mm dust		"tb" application and "Da" 5 mm dust	
Max. ambient temperature	Max. process temperature	Max. ambient temperature	Max. process temperature
60 °C [140 °F]	-40 °C [-40 °F]	60 °C [140 °F]	70 °C [158 °F]
55 °C [131 °F]	-10 °C [14 °F]	55 °C [131 °F]	100 °C [212 °F]
50 °C [122 °F]	20 °C [68 °F]	50 °C [122 °F]	130 °C [266 °F]
45 °C [113 °F]	50 °C [122 °F]	45 °C [113 °F]	160 °C [320 °F]
40 °C [104 °F]	80 °C [176 °F]	40 °C [104 °F]	190 °C [374 °F]
35 °C [95 °F]	110 °C [230 °F]	35 °C [95 °F]	200 °C [392 °F]
30 °C [86 °F]	140 °C [284 °F]	30 °C [86 °F]	200 °C [392 °F]

Tab. 3: Maximum allowable process fluid temperatures for TCD 9010 when used with hazardous dusts

If $T_{\text{process}} \leq 85^\circ \text{C}$ [185 °F], maximum surface temperature = 80 °C [176 °F]

If $T_{\text{process}} > 85^\circ \text{C}$ [185 °F], maximum surface temperature = process temperature

- The equipment internal circuits at the 4-Pin Connection – A, B, 0 and 15 V or Connector X700 (Pin 1 = 15 V, Pin 2 = 0 V, Pin 3 = A and Pin 4 = B) are not capable of withstanding a 500 V r.m.s. a.c. test to earth as required by clause 6.3.13 of IEC 60079-11:2011/EN 60079-11:2012. This shall be taken into account in any equipment installation.
- When the equipment is installed as ‘Ex d’, the connector (½” NPT or M20) shall be replaced with a suitably certified Ex d cable gland or Ex d Conduit Sealing Device and the voltage of the equipment shall not exceed 60 V DC.
- If the equipment is installed as flameproof only, it shall not subsequently be installed as intrinsically safe unless it can be verified that there has been no damage to the safety components within the intrinsically safe circuit on which safety depends by, for example, an over-voltage at the supply terminals. The safety components on which intrinsic safety depends have been assessed up to an input voltage of 60 V DC.
- Intrinsically safe installations only: A temporary connection of the TRICOR device to an uncertified programming or data download device is permitted, when the TRICOR device ANS is located in the nonhazardous area (typically prior to installation). Alternatively, such a connection may be made when the TRICOR device remains in the hazardous area, but the area is declared ‘gas-free’. The uncertified programming or data download device shall be suitably-approved as a SELV supply to IEC 60950-1, IEC 61010-1 or an equivalent standard, with a maximum output voltage of 60 V. The input terminals of the TRICOR device have a maximum voltage $U_M = 60$ V.
- The maximum pressure associated with the process medium in the internal pipes shall be limited to 160 bar.
- The following table details the various approval parameters:

Marking: Ex db ia [ia Ga] IIC T6-T3 Gb and Ex ia [ia] IIIC T85°C Da

Entity parameters for TCD 9010 (or DSL), $U_M = 60$ V, rated voltage: 12 - 24 V, rated current: 100 mA

	U_i (V)	I_i (mA)	P_i (W)	C_i (nF)	L_i (nF)
Intr. Safety supply	20	485	2.3	1.9	0.6

Tab. 4: Entity parameters for TCD 9010

Marking: Ex db [ia Ga] IIC T6-T3 Gb and Ex tb [ia Da] IIIC T85°C Db

Entity parameters for TCD 9010 (or DSL), $U_M = 60$ V, rated voltage: 12 - 24 V, rated current: 100 mA

2.4.3.2. Specific conditions of use for TCMQ with TCD 9100/9200 Transmitter

- Maximum safe area voltage must not exceed 250 V
- The TCMQ abcd-****-****-*efghij-****-**** shall only be electrically powered / connected to an overvoltage category II or better circuit as defined in IEC 60664-1 and required by Annex F of CAN/CSA-C22.2 No. 60079-11/ UL 60079-11.
- The quoted entity parameters of C_o and L_o are applicable for the distributed capacitance and inductance in cables. Where there is circuit capacitance or inductance in the connected equipment (represented by C_i and L_i) that both total more than 1 % of quoted C_o and L_o then the C_o and L_o of the connected equipment shall not exceed 50 % of the quoted C_o and L_o values.
- The maximum dust layer shall be no greater than 5 mm (T5 85 °C).
- The apparatus housing shall be connected to the potential equalising conductor in the hazardous area.



- The maximum allowable process fluid temperatures with respect to the marked temperature class and maximum surface temperature for the device in the following maximum ambient temperatures are:

Max. ambient temperature	Maximum Process Temperature per Temperature Class			
	T6	T5	T4	T3
60 °C [140 °F]	80 °C [176 °F]	80 °C [176 °F]	80 °C [176 °F]	80 °C [176 °F]
55 °C [131 °F]	85 °C [185 °F]	100 °C [212 °F]	110 °C [230 °F]	110 °C [230 °F]
50 °C [122 °F]	85 °C [185 °F]	100 °C [212 °F]	135 °C [275 °F]	140 °C [284 °F]
45 °C [113 °F]	85 °C [185 °F]	100 °C [212 °F]	135 °C [275 °F]	170 °C [338 °F]
40 °C [104 °F]	85 °C [185 °F]	100 °C [212 °F]	135 °C [275 °F]	200 °C [392 °F]
35 °C [95 °F]	85 °C [185 °F]	100 °C [212 °F]	135 °C [275 °F]	200 °C [392 °F]
30 °C [86 °F]	85 °C [185 °F]	100 °C [212 °F]	135 °C [275 °F]	200 °C [392 °F]

Tab. 5: Maximum process temperature per temperature class for TCD 9100/9200 transmitter

- The following table details the entity parameters:
 - for DSL transmitter (TCD 9200 only), $U_M = 60$ V, rated voltage: 12- 24 V, rated current: 100 mA

	U_o (V)	I_o (mA)	P_o (W)	C_i / C_o (nF)	L_i / L_o (μ H)	L_o / R_o (μ H/ Ω)
SSL Interface (IS circuit)	17.42	459	2.0	0.84 / 338	4 / 134	17.8

Tab. 6: Entity parameters for TCD 9200 only

- field connections of the TRICOR TCD 9100/9200 transmitter to the safe area :

IO Connections	Terminals	U_i (V)	I_i (mA)	P_i (W)	U_o (V)	I_o (mA)	P_o (W)	C_i (nF)	L_i (μ H)	C_o IIC (μ F)	L_o IIC (mH)
HART Active	4, 5	NA	NA	NA	28	85	0.6	NA	NA	0.07	1.6
HART Passive	5, 6	30	100	1	NA	NA	NA	15.8	36	NA	NA
Profibus PA	4, 5	17.5	380	5.32	NA	NA	NA	0.26	2.3	NA	NA
Modbus RTU	4, 5	4.2	149	0.14	4.2	118	0.12	<0.5	<50	420	2.56
IO 2 Active	8, 9	NA	NA	NA	28	87	0.6	NA	NA	0.08	1.46
IO 2 Passive	9, 10	30	100	1	NA	NA	NA	7.3	36	0.06	3.6
IO 3 Active	11, 12	NA	NA	NA	28	87	0.6	4.2	34	78	1.46
IO 3 Passive	12, 13	30	100	1	NA	NA	NA	7.3	36	61	3.6
IO 3 Relay	11, 12,13	30	100	1	NA	NA	NA	7.3	36	59	3.4
IO 4 Active	14, 15	NA	NA	NA	28	87	0.6	NA	NA	0.07	1.46
IO 4 Passive	15, 16	30	100	1	NA	NA	NA	7.3	36	NA	NA
IO 4 Relay	14, 15, 16	30	100	1	NA	NA	NA	7.3	36	NA	NA

Tab. 7: Entity parameters for TCD 9100/9200



3. Description

TCMQ Coriolis Flow Meter systems consist of a transmitter and a sensor. The following table lists the available combinations of transmitters and sensors.

Transmitter	Description
TCD 9010	<ul style="list-style-type: none">• Transmitter without display mounted on the sensor, 1 Cable Gland ½" NPT or M20x1.5
TCD 9100	<ul style="list-style-type: none">• Transmitter with display mounted on the sensor, 3 Cable Gland ½" NPT or M20x1.5, Housing Material: aluminum
TCD 9200	<ul style="list-style-type: none">• Remote Display with wall bracket, 3 Cable Gland ½" NPT or M20x1.5, Housing Material: aluminum• Link Module mounted on the sensor

Tab. 8: Available combinations of transmitters and sensors

3.1. Design

Versions

The flow meter uses the Coriolis principle to measure flow and is available in a remote and a compact version.

- Compact version: The TCD 9010 (without display) or the TCD 9100 (display version) together with the Coriolis sensor is a unit where the transmitter is directly mounted on the sensor.
- Remote version with Link Module (TCD 9200): The TRICOR Coriolis sensor is equipped with a directly mounted co-processor and a remote transmitter with display. The 4-wire connection between the transmitter and the sensor provides power and high-integrity digital communication.

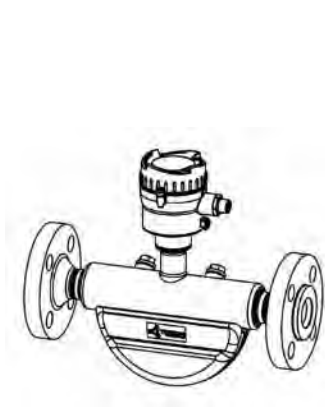

Fig. 3: Compact version with TCD 9010 transmitter

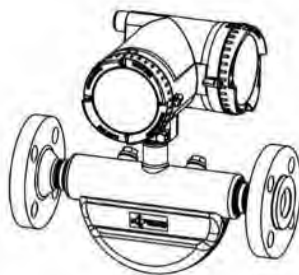

Fig. 4: Compact version with TCD 9100 transmitter

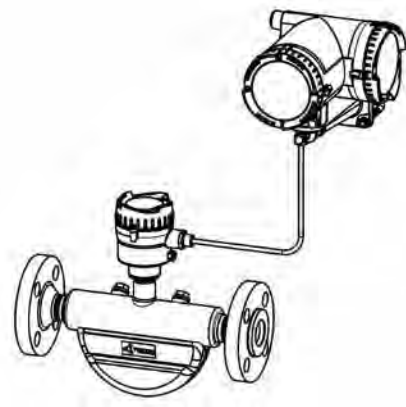

Fig. 5: Remote version with TCD 9200 transmitter



Sensor design

All primary process measurement of massflow, volumeflow, density and process temperature are made in the TCD transmitter.

The sensor comprises two parallel bent tubes welded directly to the process connections at each end via a manifold. The sensor is available in an design for hazardous area installations.

A list of the materials used can be found under "Sensor Design" (chapter 11.6.1, page 162).

In the TCD 9200 remote configuration, the sensor front end (TCD 9010) is available in an painted aluminum, with an ingress protection grade of IP67/NEMA 4X. The communication and power supply is done via a 4-wire connection by means of M12 connector.

Sensor overview

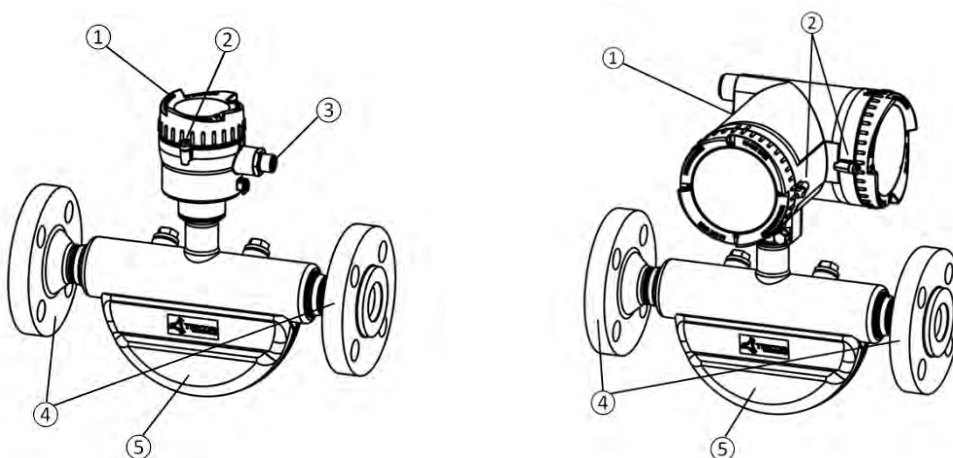

Fig. 6: Overview compact configuration

- ① Sensor transmitter (TCD 9010 or TCD 9200)
- ② Lid-lock
- ③ Cable connection via 4-pin M12 plug (only TCD 9200) or cable gland
- ④ Process connections (version dependent)
- ⑤ Sensor housing

Transmitter design with display (TCD 9100 and TCD 9200)

The transmitter processes the primary values from the sensor and calculates derived values. It provides up to four configurable I/Os. On channel 1, the communication interfaces HART, PROFIBUS DP, PROFIBUS PA or Modbus RTU RS485 are possible. Outputs 2, 3 and 4 can be individually configured as I/Os, depending on the version. A local display (human machine interface - HMI) is available, which consists of a display and four buttons for user interaction. The transmitter includes functionalities such as Standard volume flow, fractions, totalizers, dosing, access control, diagnostics, configuration and logging.

The transmitter has a modular design with replaceable electronic modules and connection boards to maintain separation between functions and facilitate field service.



Transmitter exploded view

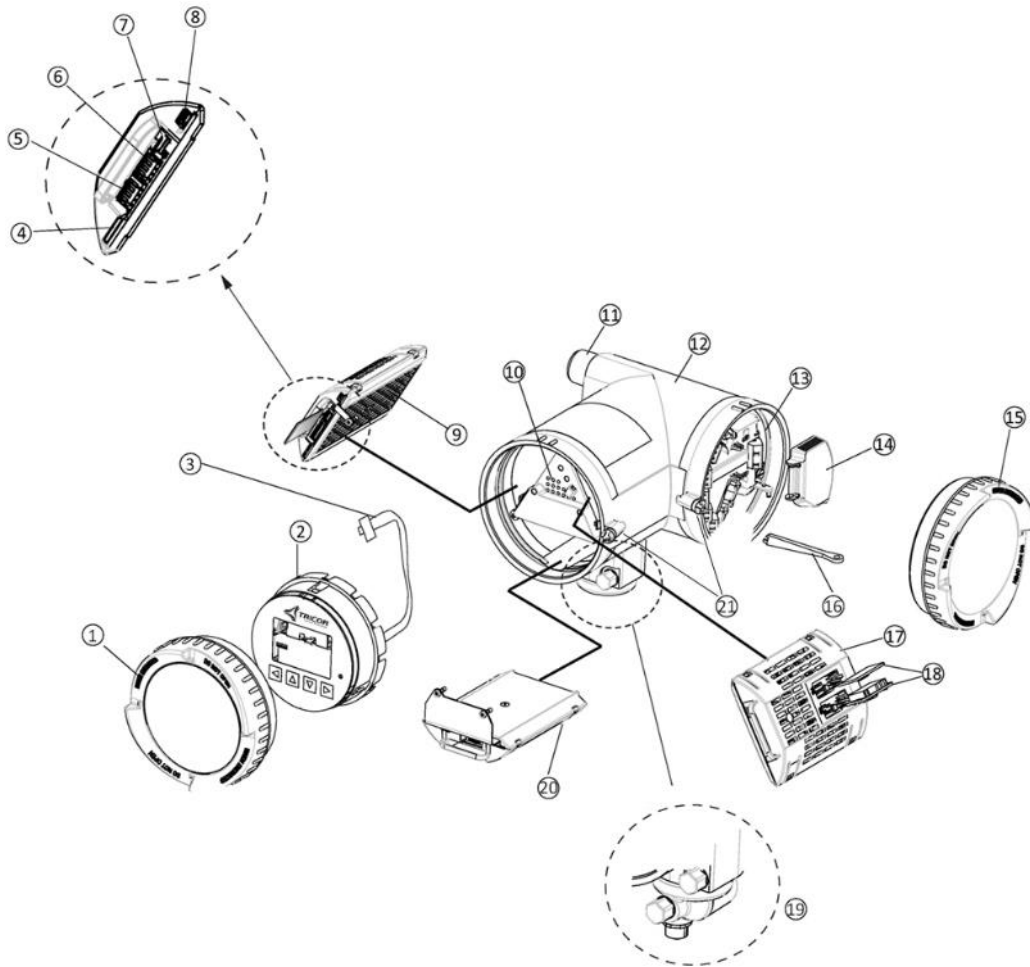

Fig. 7: Transmitter exploded view

- | | | | |
|---|-----------------------------------|---|--|
| ① | Housing cover with viewing window | ⑫ | Transmitter housing |
| ② | Display (HMI) | ⑬ | Terminal space |
| ③ | HMI data cable | ⑭ | Power supply terminal protection cover |
| ④ | SD card | ⑮ | Housing cover |
| ⑤ | DIP switch (for custody transfer) | ⑯ | Wiring tool |
| ⑥ | DIP switch (for HART and Modbus) | ⑰ | I/O cassette (optional) |
| ⑦ | HMI port | ⑱ | I/O configuration keys (optional) |
| ⑧ | USB service port | ⑲ | M12 socket
(version dependent for TCD 9200) |
| ⑨ | Transmitter cassette | ⑳ | Sensor module |
| ⑩ | Power supply module | ㉑ | Cover lock |
| ⑪ | Cable entry | | |



3.2. Ordering Codes and Accessories

3.2.1. Ordering Code

	TCMQ	XXXX	-	XX	XX	-	XX	XX	-	X	-	X	X	X	EXX	-	XXX	-	X	
Sensor Connection																				
TCMQ 6400, DN15, DN6 [¼"]																				
TCMQ 6400, DN15, DN10 [⅜"]																				
TCMQ 6400, DN15, DN15 [½"]																				
TCMQ 6400, DN15, DN20 [¾"]																				
TCMQ 6400, DN15, DN25 [1"]																				
TCMQ 018K, DN25, DN15 [½"]																				
TCMQ 018K, DN25, DN25 [1"]																				
TCMQ 018K, DN25, DN32 [1¼"]																				
TCMQ 018K, DN25, DN40 [1½"]																				
TCMQ 070K, DN50, DN40 [1½"]																				
TCMQ 070K, DN50, DN50 [2"]																				
Wetted Material and Finish																				
Standard 316L W1.4435 W1.4404 Ra 1.6 µm																				
Process Connections¹⁾																				
see page 14																				
Installation length																				
Standard 316L W1.4435 W1.4404 Ra 1.6 µm (see page 14)																				
Mechanical Options																				
Temperature																				
-60°C ... +200°C [-76°F ... 392°F] (non hazardous area)																				
Accuracy																				
Mass flow ±0.1% o.r. [±0.35% o.r. for gas], density ±5 kg/m³, volume flow ±0.5% o.r., repeatability ±0.05% o.r.																				
Mass flow with improved density ±0.5 kg/m³, with volume flow ±0.1%																				
Transmitter Options																				
Mount version																				
TCD 9100 - Direct meter mount transmitter with display, IP67, NEMA 4X, ½" NPT, M20x1.5, 24 V DC / 100 ... 240 V AC																				
TCD 9200 - Wall-mount transmitter (display + link module), ALU, IP67, NEMA 4X, ½" NPT, M20x1.5, 24 V DC / 100 ... 240 V AC																				
TCD 9010 - Direct meter mount transmitter without display, ½" NPT, M20x1.5, 24 V DC																				
Interface																				
Non-Ex: 4 ... 20 mA HART active/passive																				
(Ex) 4 ... 20 mA HART active																				
(Ex) 4 ... 20 mA HART passive																				
(Ex) Profibus PA																				
(Non-Ex) Profibus PA																				
(Non-Ex) Profibus DP																				
(Non-Ex) Modbus RTU																				
(Ex) Modbus RTU																				
Plug-in I/O-Card																				
none																				
(Non-Ex) signal I/O, signal I/O, signal I/O																				
(Non-Ex) signal I/O, signal I/O, relay																				
(Ex-active) signal I/O, signal I/O, signal I/O																				
(Ex-active) signal I/O, signal I/O, relay																				
(Ex-passive) signal I/O, signal I/O, signal I/O																				
(Ex-passive) signal I/O, signal I/O, relay																				
Ex-Protection																				
without protection																				
ATEX/IECEx/EAC Ex, Zone 1/Zone 21: Group IIC and IIIC, T6 ²⁾																				
cCSAus: US/CAN ²⁾																				
ATEX Zone 2: II 3G Ex nA IIC T6 Gc																				
CSA/ATEX/IECEx/EAC Ex, Zone 1/Zone 21: Group IIC and IIIC, T6																				
Remote Cable																				
TCD 9200 Remote M12 Cable, 3 m [10 ft], Standard																				
TCD 9200 Remote M12 Cable, 6 m [20 ft]																				
TCD 9200 Remote M12 Cable, 10 m [33 ft]																				
TCD 9200 Remote M12 Cable, 15 m [49 ft.]																				
TCD 9200 Remote M12 Cable, 20 m [66 ft.]																				
TCD 9200 Remote M12 Cable, 30 m [98 ft.]																				
TCD 9200 Remote M12 Cable, 50 m [164 ft.]																				
Customer Specifics																				
Customer specifics, special options not yet coded																				

¹⁾ For connections not indicated with installation length, please contact manufacturer.

²⁾ For details see "Certificates" (chapter 11.15, page 177).



3.2.2. Process Connection and Installation Length in mm [inch]

Process connection ³⁾	Code	TCMQ 6400 DN15					TCMQ 018K DN25				TCMQ 070K DN50	
		DN6 [¼"]	DN10 [¾"]	DN15 [½"]	DN20 [¾"]	DN25 [1"]	DN15 [½"]	DN25 [1"]	DN32 [1¼"]	DN40 [1½"]	DN40 [1½"]	DN50 [2"]
Weld neck flange EN1092-1 B1. Pressure PN16	A0			265 [10.43]		265 [10.43]		360 [14.17]	360 [14.17]	365 [14.37]	610 [24.02]	610 [24.02]
Weld neck flange EN1092-1 B1. Pressure PN40	A1			265 [10.43]	265 [10.43]	265 [10.43]		360 [14.17]	360 [14.17]	365 [14.37]	610 [24.02]	610 [24.02]
Weld neck flange EN1092-1 B1. Pressure PN63	A2			265 [10.43]				360 [14.17]			610 [24.02]	610 [24.02]
Weld neck flange EN1092-1 B1. Pressure PN100	A3			270 [10.63]		275 [10.83]		360 [14.17]		365 [14.37]	610 [24.02]	610 [24.02]
Weld neck flange EN1092-1 D. Pressure PN40	A5			270 [10.63]							610 [24.02]	610 [24.02]
Weld neck flange EN1092-1 D. Pressure PN63	A6										610 [24.02]	610 [24.02]
Weld neck flange EN1092-1 D. Pressure PN100	A7										610 [24.02]	610 [24.02]
Weld neck raised face flange. ASME B16.5 Class 150	D1			270 [10.63]	270 [10.63]			360 [14.17]		365 [14.37]		620 [24.41]
Weld neck raised face flange. ASME B16.5 Class 300	D2			270 [10.63]	270 [10.63]			360 [14.17]		380 [14.96]		620 [24.41]
Weld neck raised face flange ASME B16.5 Class 600	D3			270 [10.63]	285 [11.22]			360 [14.17]		380 [14.96]		620 [24.41]
ST-Pipe thread ISO228-1 G	E1	265 [10.43]		265 [10.43]				365 [14.37]				620 [24.41]
ST-Pipe thread ASME B1.20.1 NPT	E3	265 [10.43]		270 [10.63]				365 [14.37]				620 [24.41]
ST-Hygienic thread DIN 11851	F1		265 [10.43]	265 [10.43]		193 [7.60]		360 [14.17]	360 [14.17]		610 [24.02]	610 [24.02]
ST-Hygienic clamp DIN32676,(inch) (ASME), Row C, („Tri-clamp“)	G1							360 [14.17]		360 [14.17]		
ST-DIN11864-1 GS Form A Row A, Form A = O-ring type hygienic, Asceptic thread connector, Hygienic Class H3	H1			265 [10.43]	265 [10.43]			360 [14.17]			620 [24.41]	610 [24.02]
ST-DIN11864-2 BF Form A Row A, Form A = O-ring type hygienic, Asceptic flange connector, Hygienic Class H3	H2			265 [10.43]	265 [10.43]			360 [14.17]		274 [10.78]	620 [24.41]	610 [24.02]
ST-Hygienic clamp ISO 2852	J1					265 [10.43]		360 [14.17]		274 [10.78]	610 [24.02]	610 [24.02]
ST-Hygienic thread ISO 2853	J5					265 [10.43]		360 [14.17]		274 [10.78]		610 [24.02]
ST-Hygienic thread SMS 1145, male. Pressure PN6	K1			265 [10.43]				360 [14.17]				610 [24.02]
ST-Weld neck raised face flange, JIS B2220/10K	L2			265 [10.43]		265 [10.43]						
ST-Weld neck raised face flange, JIS B2220/20K	L4			265 [10.43]		265 [10.43]						
ST-Weld neck raised face flange, JIS B2220/40K	L6			265 [10.43]		265 [10.43]						610 [24.02]

³⁾ Connections without installation length are not possible or need manufacturer release. Please contact the manufacturer.



3.2.3. Accessories

Accessories for TCMQ series	Ordering Code
DAkkS-Calibration (ILAC) DIN EN ISO/IEC 17025:2018	3.KAL-0100
Oxygen cleaning TCM	219269
TAG Plate (1.4404 / 316L)	219705
Press test certificate PED	223684
Material cert EN 10204-3.1	224005
Fact cert to EN 10204 2.1	224006
Fact cert to EN 10204 2.2	224007
Welding inspection report	224008
Cleaning for oil and grease	224011

3.3. Features

- Use as HART, Modbus RTU RS485 and PROFIBUS PA/DP slave in operation with third party automation systems
- Available in compact and remote design
- Full graphical local display (HMI), with 6 user views and trend curves
- SD-Card for memory backup, logging and documentation storage (certificates etc.)
- USB service interface
- High immunity against process noise
- Fast response to step changes in flow due to high update rate (100 Hz) on all process values
- Configurable upper and lower alarms and warning limits for process values
- Independent low flow cut-off settings for volume flow and mass flow
- Zero-point adjustment (initiated locally on HMI panel or by process control system)
- Variable filtering for optimal process noise damping
- Three configurable totalizers for accumulation of flow process values
- Simulation of process values, IO outputs and alarms
- Empty tube monitoring
- Enabling alarms for visibility on all outputs (HMI, status and communication)
- Comprehensive diagnostics (NAMUR or TRICOR standard) for troubleshooting and sensor checking
- Firmware update
- Use in hazardous areas according to specification
- Data logging of process values and parameter value change in Sensor SD-Card
- Peak indicators – logging of min & max process peak values with time stamp information
- Alarm delay
- Damping filtering system for process values at HMI or outputs
- Spare part replacement
- Selection of active or passive output signals in none hazardous areas
- Intelligent filtering system for aerated flow



- Up to four input/output channels:
 - Channel 1: can be:
 - Profibus DP 12 Mbit/s
 - Profibus PA Profil 4.0
 - Current HART 7.5 output (4 ... 20 mA)
 - Modbus RTU RS485
 - Channel 2: Signal output can be parameterized for:
 - Current output (0/4 ... 20 mA)
 - Pulse output
 - Frequency output
 - Status output
 - Channel 3 and 4: Signal output:
 - Current output (0/4 ... 20 mA)
 - Pulse output
 - Frequency output
 - Status output
 - Pulse or frequency redundancy mode (Channel 2 together with channel 3)
 - Channels 3 and 4: Relay output; can be parameterized as:
 - Status output
 - Channels 3 and 4: Signal input; can be parameterized as:
 - Totalizer control
 - Dosing control
 - Zero point adjustment
 - Freezing of process values
 - Forcing of outputs
- Current, frequency, and pulse outputs with configurable fail safe mode
- Totalizer control (resetting of totalizers)
 - Zero adjustment
 - Freezing of process values
 - Forcing of outputs
- Measurement of:
 - Volume flow
 - Mass flow
 - Standard volume flow
 - Density
 - Fraction A (mass flow or volume flow)
 - Fraction B (mass flow or volume flow)
 - Fraction A %
 - Fraction B %
 - Medium temperature
- Three totalizers for accumulation of mass flow, volume flow and standard volume flow, depending on setting, of:
 - Mass flow measurement
 - Volume flow measurement
 - Fraction A and B measurement (mass flow or volume flow)
 - Standard volume flow



3.4. Applications

Measurement of liquids and gases

TRICOR PRO Series Coriolis Mass Flow Meters are designed for measurement of a variety of liquids and gases. The flow meters are multi-parameter devices offering accurate measurement of massflow, volume flow, density, temperature and, depending on product variants, fraction, including industry-specific fractions.

Main applications

The main applications of the Coriolis Flow Meter can be found in all industries, such as:

- Chemical & Pharma: detergents, bulk chemicals, alkalis, pharmaceuticals
- Automotive: fuel injection nozzle & pump testing, filling of AC units, engine consumption, paint robots
- Oil & Gas: filling of gas bottles, furnace control, test separators, bore-hole plasticizer dosing, water-cut metering
- Water & Waste Water: dosing of chemicals for water treatment

3.5. Approvals

NOTE:

For further details see “Bus Communication” (chapter 11.9, page 166).

The device is available with approvals for general purpose and for hazardous areas. In all cases, check the nameplate on your device, and confirm the approval rating.

3.6. Theory of Operation

The Coriolis principle of measurement

The flow measurement is based on the Coriolis law of motion. Particles moving in a rotating/oscillating system will resist imposed oscillations in a manner consistent with their mass and velocity (momentum). Oscillation produced by a Coriolis Flow Meter where the process media is accelerated around bends results in phase distortions of the measuring tubes.

The TRICOR TCMQ sensors are energized by an electromagnetic (voice coil) driver circuit which oscillates the pipes at their resonant frequency. Two pickups are placed symmetrically on either side of the driver to provide position signals for digital processing.

When the media flows through the sensor, Coriolis force will act on the measuring tubes and cause deflection which can be measured as a phase shift between Pickup 1 and Pickup 2. The phase shift is proportional to the mass flowrate.

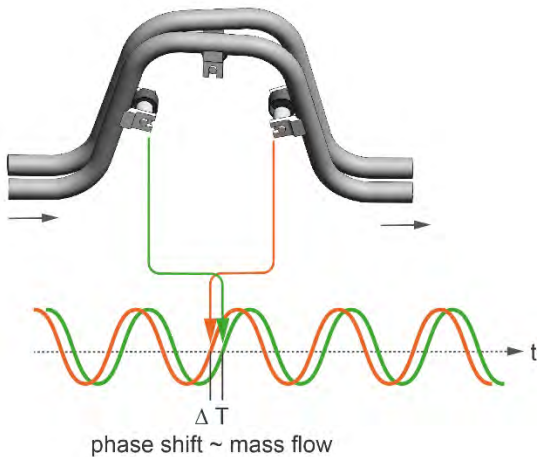

Fig. 8: Principle of operation Coriolis Mass Flow Meter

The frequency (or period) of the vibration is a direct function of the process media density.

The vibration amplitude of the pipe loop is regulated to ensure a stable output from the 2 pickups. The temperature of the sensor tubes is measured to provide accurate compensation of the material stiffness. As a result the process media temperature is also accurately measured.

The flow proportional phase signal from the pickups, the temperature measurement and the driver frequency enable calculation and reporting of mass, density, volume, and temperature.

Digital signal processing (DSP)

The analog to digital conversion takes place in an ultra low noise sigma delta converter with high signal resolution. With fast digital signal processing massflow and density values are calculated using a patented DFT technology (Discrete Fourier Transformation). The combination of this patented DFT technology and the fast DSP enables short response time (< 10 ms) to changes in the measured values.

The built-in noise filter is configurable and can be used for improving the performance of the flow meter, in case the installation and application conditions are not ideal. Typical process noise such as gas bubbles (two-phase-flow) can be reduced through the filter functions.



4. Installing/Mounting

This chapter gives detailed instructions on mounting the transmitter and sensor to take best advantage of the flexible arrangements built into the product, and to aid in planning the physical locations of the flow meter parts.

With compact types (TCD 9100) the transmitter can be rotated on the sensor pedestal through about 330°.

For remote types (TCD 9200), as well as about 330° rotation on the support post, 360° rotation in the perpendicular plane is provided. The display can be rotated through 360° in 30° steps. The remote mounted transmitter can therefore be oriented in practically any direction.

With remote installations it is advisable to mount the transmitter in a location convenient for using the display, with a firm backing from a wall, beam or post.

If the process piping is subjected to high vibration, remote installation is recommended to shield the electronics from shaking.

The main flow direction should correspond to the arrow mark on the device.

4.1. Basic Safety Notes

CAUTION!

Hot surfaces resulting from hot process media

Risk of burns resulting from surface temperatures above 70 °C [155 °F].

Take appropriate protective measures, for example contact protection.

Make sure that protective measures do not cause the maximum permissible ambient temperature to be exceeded. Refer to the information in “Technical Data” (chapter 11, page 157).

4.1.1. Note

NOTE:

Hot surface is only an issue for media or ambient temperature above 50 °C [122 °F].

WARNING!

Wetted parts unsuitable for the process media

Risk of injury or damage to device.

Hot, toxic and corrosive media could be released if the process medium is unsuitable for the wetted parts.

Ensure that the material of the device parts wetted by the process medium is suitable for the medium. Refer to the information in “Technical Data” (chapter 11, page 157).

NOTE:

Material compatibility

The manufacturer can provide you with support concerning selection of sensor components wetted by process media. However, you are responsible for the selection of components. The manufacturer accepts no liability for faults or failures resulting from incompatible materials.



WARNING!**Unsuitable process connections**

Risk of injury or poisoning.

In case of improper mounting hot, toxic and corrosive process media could be released at the connections.

Ensure that process connections (such as flange gaskets and bolts) are suitable for connection and process media.

WARNING!**Exceeded maximum permissible operating pressure**

Risk of injury or poisoning.

The maximum permissible operating pressure depends on the device version, pressure limit and temperature rating. The device can be damaged if the operating pressure is exceeded. Hot, toxic and corrosive process media could be released.

Ensure that maximum permissible operating pressure of the device is not exceeded. Refer to the information on the sensor nameplate and/or in "Technical Data" (chapter 11, page 157).

WARNING!**Unprotected cable ends**

Risk of explosion through unprotected cable ends in hazardous areas.

Protect unused cable ends in accordance with IEC/EN 60079-14.

WARNING!**Loss of explosion protection**

Risk of explosion in hazardous areas if the device is open or not properly closed.

Close the device as described in "Installing/Mounting" (chapter 4, page 27).

CAUTION!**External stresses and loads**

Damage to device by severe external stresses and loads (e.g. thermal expansion or pipe tension). Process media can be released.

Prevent severe external stresses and loads from acting on the device.

4.1.2. Installation Location Requirements



TRICOR TCMQ Series Flow Meters has IP65 rating by default. With the optional IP67/NEMA 4X enclosure rating the meters are suitable for indoor and outdoor installations.

Process pressure and medium temperature

If applicable, make sure that specifications for rated process pressure (PS) and medium temperature (TS) plus ambient temperature that are indicated on the device nameplate/label will not be exceeded.



Aggressive atmospheres

Ensure that the device is suitable for the application and that it is installed where there is no risk of penetration of aggressive vapors.

Direct sunlight

Prevent the device from overheating or materials becoming brittle due to UV exposure by protecting it from direct sunlight. Make sure that the maximum permissible ambient temperature is not exceeded. Refer to the information in “Operating Conditions” (chapter 11.7, page 165).

WARNING!

Equipment used in hazardous areas

Risk of explosion in hazardous areas.

Special requirements apply to the location and installation of the device. See “Installation in Hazardous Areas” (chapter 2.4.3, page 14).

WARNING!

Strong vibrations

Risk of explosion in hazardous areas.

In plants with strong vibrations, mount the transmitter in a low vibration environment.

CAUTION!

Strong vibrations

Damage to device

In plants with strong vibrations, mount the transmitter in a low vibration environment away from the sensor.

4.1.3. Proper Mounting

NOTE:

Incorrect mounting

The device can be damaged, destroyed, or its functionality impaired through improper mounting.

Before installing ensure there is no visible damage to the device.

Make sure that process connectors are clean, and suitable gaskets and glands are used.

Mount the device using suitable tools. Refer to the information in “Construction” (chapter 11.6, page 161) for installation torque requirements.

CAUTION!

Loss of type of protection

Damage to device if the enclosure is open or not properly closed.

The type of protection specified on the nameplate or in “Sensor Design” (chapter 11.6.1, page 162) is no longer guaranteed.

Make sure that the device is securely closed.



4.2. Installation Instructions

4.2.1. Transmitter Installation

4.2.1.1. Mounting kit of the TCD 9200 remote display

Mounting on wall

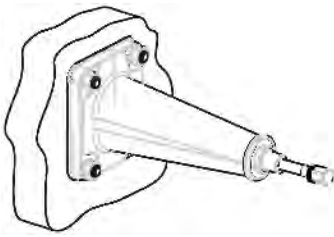

Fig. 9: Mounting on wall

1. Prepare holes with aid of mounting bracket.
2. Fasten mounting bracket with black cushion pad to wall (torque 10 Nm).

Mounting on pipe

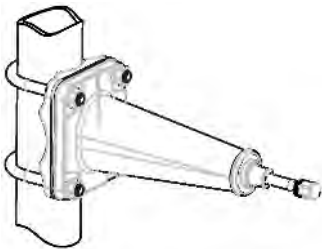

Fig. 10: Mounting on pipe

1. Mount mounting bracket with cushion pad on pipe using fastening brackets/U-bolts and supplied pipe adaptor.
2. Tighten nuts (torque: 10 Nm).

NOTE:

U-bolts and other miscellaneous hardware are not supplied with the flow meter.

4.2.1.2. Mounting the transmitter TCD 9200

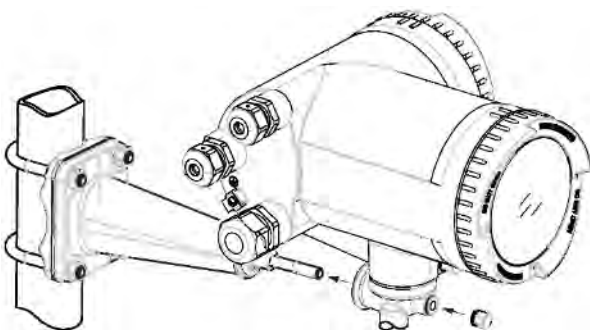

Fig. 11: Mounting the transmitter

1. Remove locking cap from mounting bracket.
2. Mount transmitter on mounting bracket taking care that the flutes on the mating faces are correctly engaged.
3. Firmly tighten locking cap on mounting bracket (torque: 25 Nm).



4.2.1.3. Turning the Transmitter TCD 9100 (compact version)

Horizontal Rotation

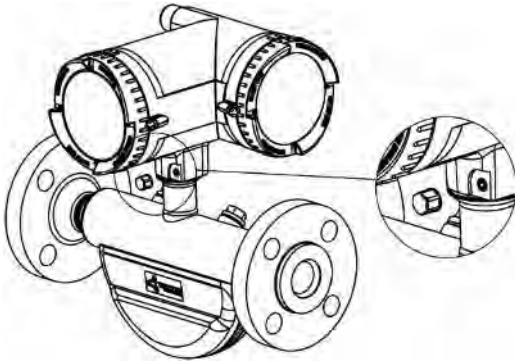

1. Unscrew cap from lock screw.
2. Loosen lock screw at transmitter pedestal using 5 mm Allen key.
3. Carefully rotate transmitter into desired position.
4. Firmly tighten lock screw (torque: 10 Nm).
5. Replace cap onto lock screw (torque: 10 Nm).

Fig. 12: Turning the TCD 9100 transmitter (compact version) - Horizontal rotation

4.2.1.4. Turning the Transmitter TCD 9200 (remote version)

The transmitter TCD 9200 can be turned horizontally and tilted vertically.

Horizontal Rotation

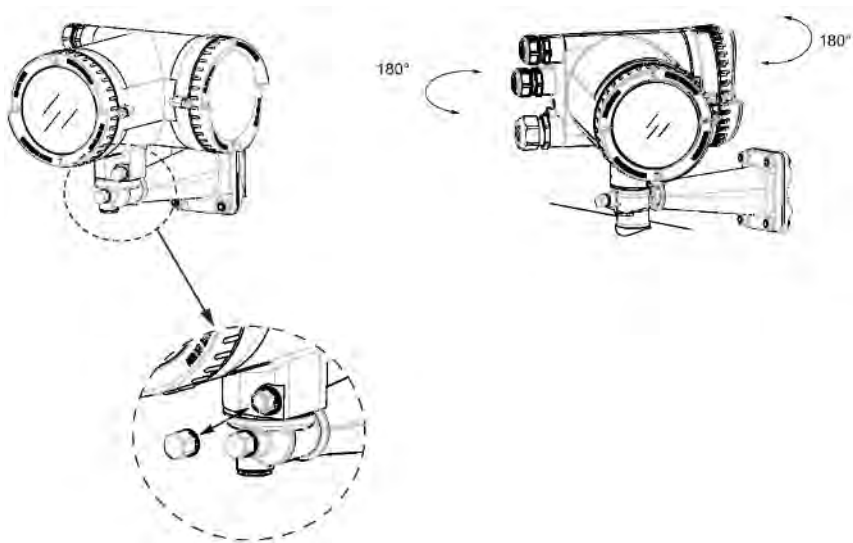

1. Unscrew cap from lock screw.
2. Loosen lock screw at transmitter pedestal using 5 mm Allen key.
3. Carefully rotate transmitter into desired position.
4. Firmly tighten lock screw (torque: 10 Nm).
5. Replace cap onto lock screw (torque: 10 Nm).

Fig. 13: Turning the TCD 9200 Display (remote version) - Horizontal rotation



Vertical Rotation

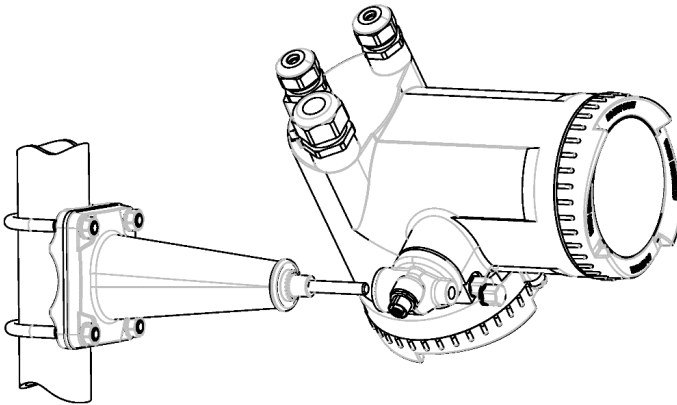

1. Loosen locking cap at end of mounting bracket by three turns.
2. Carefully loosen and rotate transmitter into desired position (15° steps).
3. Firmly tighten locking cap (torque: 25 Nm).

Fig. 14: Turning the TCD 9200 display - Vertical rotation (remote version)

4.2.1.5. Turning the Local Display

The local display can be turned in steps of 30° in order to optimize the viewing angle.

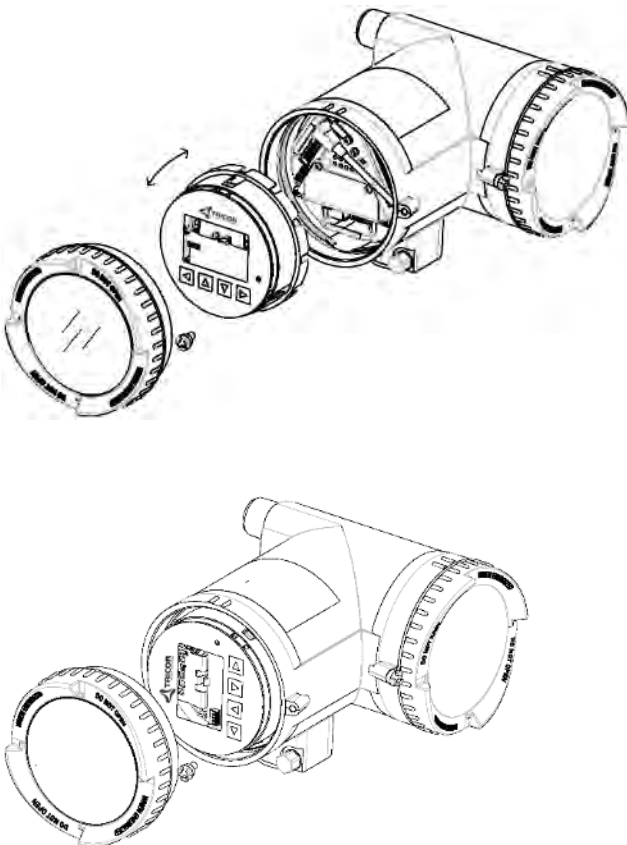

1. Remove lid lock screw of display cover.
2. Remove display cover.
3. Use a small screwdriver or blade to loosen the three retaining clips within the transmitter.
4. Carefully pull out local display.
5. Turn display into desired position.
6. Carefully push display back into housing. Use a small screwdriver or blade to open the three retaining clips within the transmitter when pushing the display home.
7. Remove O-ring from lid.
8. Reinstall display cover until mechanical stop. Wind back lid by one turn.
9. Mount O-ring by pulling it over the display cover and turn display cover until you feel friction from the O-ring on both sides. Wind display cover further by one quarter of a turn to seal on the O-ring.
10. Reinstall and tighten lid lock screw.

Fig. 15: Turning the local display



4.2.2. Sensor Installation

4.2.2.1. Determining a Location

CAUTION!

Electromagnetic fields

Do not install the flow meter in the vicinity of strong electromagnetic fields, for example near motors, variable frequency drives, transformers etc.

Upstream/downstream

- No pipe run requirements, that is straight inlet/outlet sections are not necessary.
- Avoid long drop lines downstream from the sensor to prevent process media separation causing air/vapor bubbles in the tube (min. back pressure: 0.2 Bar).
- Avoid installing the flow meter immediately upstream of a free discharge in a drop line.

Location in the system

The optimum location in the system depends on the application:

Liquid applications

Gas or vapor bubbles in the fluid may result in erroneous measurements, particularly in the density measurement.

- Do not install the flow meter at the highest point in the system, where bubbles will be trapped.
- Install the flow meter in low pipeline sections, at the bottom of a U-section in the pipeline.

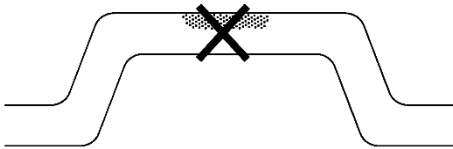

Fig. 16: Liquid applications, wrong location with trapped air/gas

Gas applications

Vapor condensation or oil traces in the gas may result in erroneous measurements.

- Do not install the flow meter at the lowest point of the system.
- Install a filter.

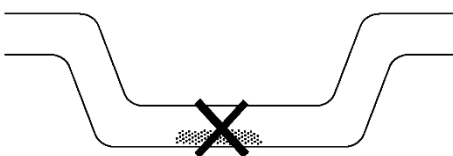

Fig. 17: Gas applications, wrong location with trapped oil



4.2.2.2. Orientation of the Sensor

Flow Direction

The flow direction is indicated by the arrow on the sensor. Flow in this direction will be indicated as positive by default. The sensitivity and the accuracy of the sensor do not change with reverse flow.

The indicated flow direction (positive/negative) is configurable.

CAUTION!

Accurate measurement

The sensor must always be completely filled with process media in order to measure accurately.

NOTE:

Orienting the sensor

To avoid water or moist ingress, transmitters should be oriented with cable entrances aiming downwards.

Orienting the sensor

The sensor operates in any orientation. The optimal orientation depends on the process fluid and the process conditions. It is recommended that the sensor is oriented in one of the following ways:

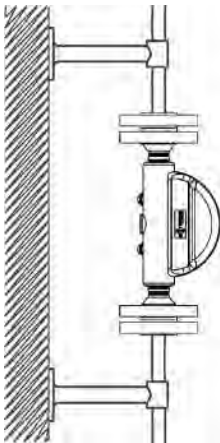

Vertical installation with an upwards flow

Fig. 18: Vertical orientation, upwards flow

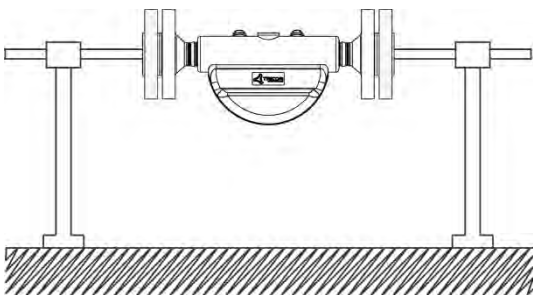

Horizontal installation, tubes down
(recommended for liquid applications)

Fig. 19: Liquid applications, wrong location with trapped air/gas

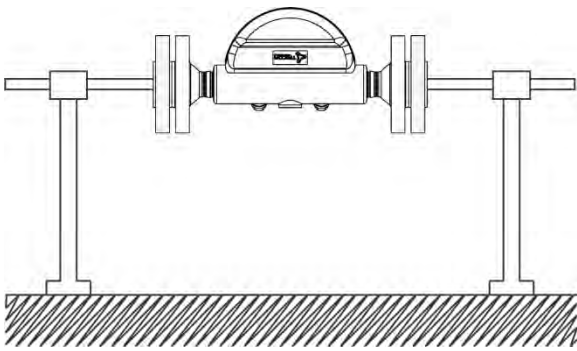

Horizontal installation, tubes up
(recommended for gas applications)

Fig. 20: Horizontal orientation; tubes up

4.2.2.3. Installation in a Drop Line

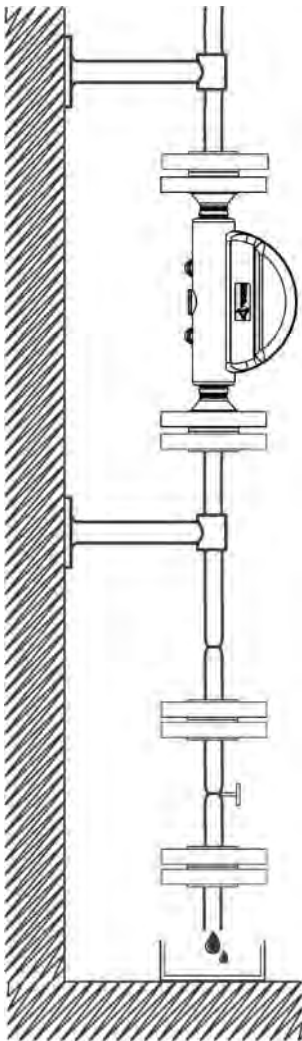

Fig. 21: Installation in drop line

Installation in a drop line is only recommended if a pipeline reduction or orifice with a smaller cross-section can be installed to create back-pressure and prevent the sensor from being partially drained while measuring.



4.2.2.4. Mounting the Sensor

- Install the sensor in well-supported pipelines in order to support the weight of the flow meter.
- Center the connecting pipelines axially in order to assure a stress-free installation. The flow meter must not be used to bring the rest of the pipework into line; make sure the pipework is correctly aligned before inserting the flow sensor.
- Install two supports or hangers symmetrically and stress-free on the pipeline in close proximity to the process connections.

NOTE:**Handling**

Never lift the flow meter using the electronics housing, but always by the sensor housing.

Avoid vibrations

- Make sure that any valves or pumps upstream of the sensor do not cavitate and do not transmit vibrations into the sensor.
- Decouple vibrating pipeline from the flow sensor using flexible tube or couplings.

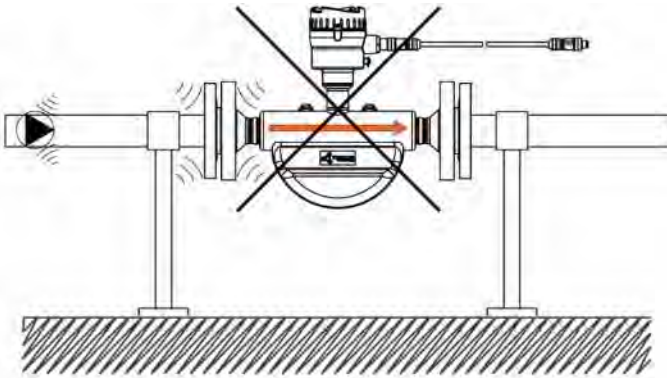

Fig. 22: Sensor installation with non-flexible pipes is not recommended in vibrating environment

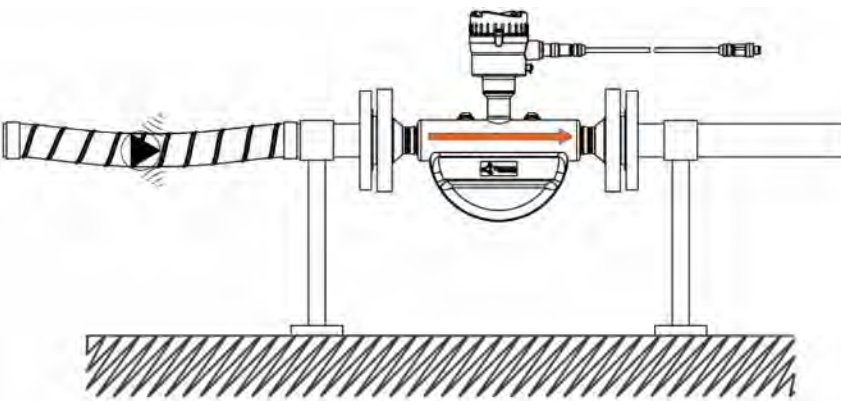

Fig. 23: Flexible pipes recommended in vibrating environment



Avoid cross talk

If operating more than one flow meter in one or multiple interconnected pipelines there is a risk of cross talk.

Prevent cross talk in one of the following ways:

- Mount sensors on separate frames
- Decouple the pipeline using flexible tube or couplings

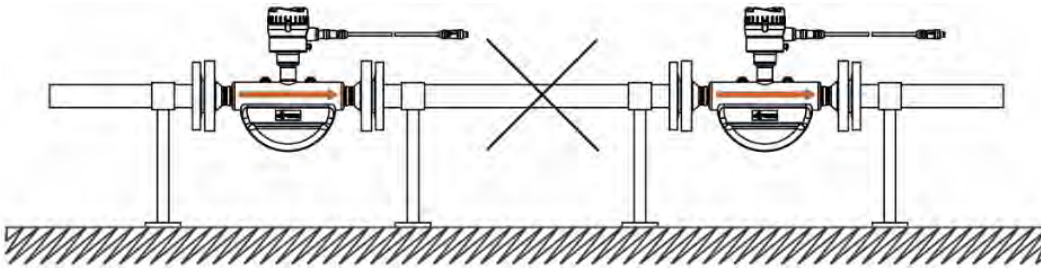

Fig. 24: High risk of cross talk when using non-flexible pipes

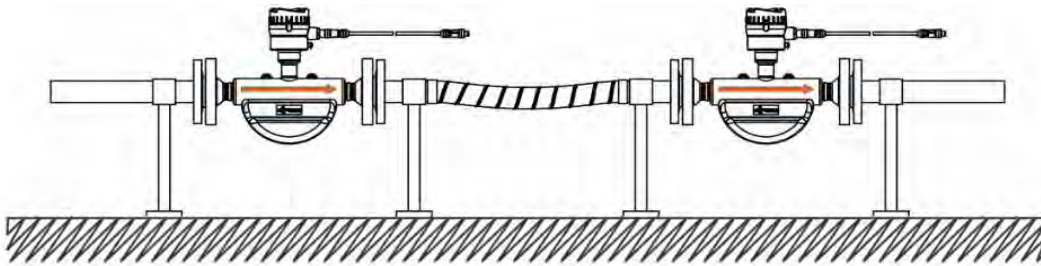

Fig. 25: Flexible pipes recommended in vibrating environment

4.2.2.5. Sanitary application installation for 3A authorized meters (US market only)

3A authorized sensors used in sanitary application must be installed in such a manner that the flow tubes are self-draining.

The preferred orientation is vertical (A). Horizontal orientation (B) is also allowed, but take care that air does not get trapped in tubes (see chapter 4.2.2.1, page 33) as this can both cause bacteria growth, but will also cause erroneous measurements.

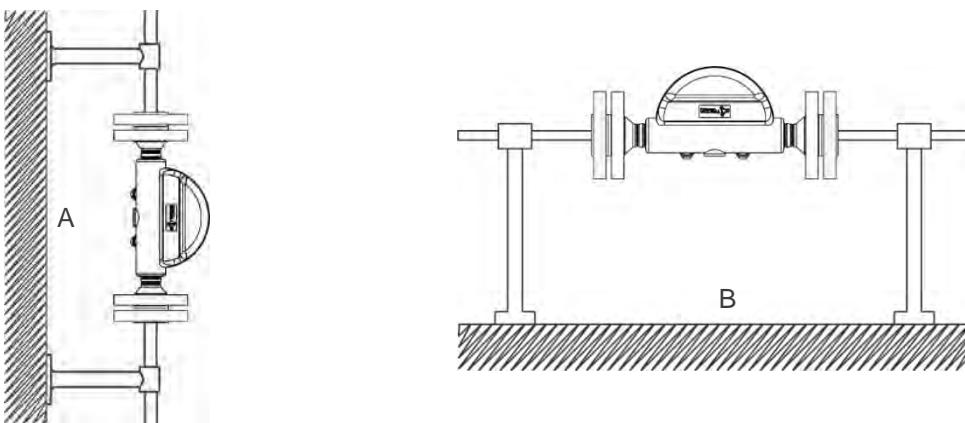

Fig. 26: Sensor installation in sanitary applications (US market only)



4.2.2.6. Hydrostatic Testing

The flow meter is pressure-tested before delivery to 1.5 times the rated working pressure of the sensor.

- In the case of process connections pressure-rated less than 100 bar, the connection is the limiting component.
- In the case of process connections pressure-rated above 100 bar, the sensor is the limiting component.

In all cases the maximum allowed hydrostatic test pressure (MATP) of the flow meter is 1.5 times the marked MAWP (PS) at 20 °C [68 °F].

Pressure test of a completed flow system with piping and other components can be done at pressures no higher than 1.5 times the marked MAWP (PS) at 20 °C [68 °F] of the lowest rated system component.

4.2.2.7. Installing with Insulation

Insulation is added to pipes and equipment for two reasons:

- To protect personnel from exposure to hot or cold surfaces, thereby preventing burns and other injuries
- To prevent heat loss into or out of the process, thereby preserving the process temperature and process medium conditions.

In both cases, insulation can have the unexpected effect of shrouding other attached components not intended or designed for the process temperatures. When installing an TCMQ sensor with insulation, observe the following rules:

- Do not cover any part of the transmitter pedestal. The pedestal is designed to separate the process temperature from the transmitter TCD 9010 and TCD 9100.
- Form a 90° cone around the pedestal
- Allow free movement of air around the electronics housing to allow temperature equalisation to occur at all times.

NOTE:

The pedestal of the transmitter has a sufficient internal distance from the measuring tubes. If the body of the sensor is insulated, the process medium is not exposed to excessive temperature losses through the cone around the base.

NOTE:

If the device is installed in an explosion-protected area, no insulation of the device is permitted.



4.3. Disassembly

DANGER!

Pressure applications

Danger to personnel, system and environment will result from improper disassembly.

Never attempt to loosen, remove, or disassemble process connection while vessel contents are under pressure.

WARNING!

Incorrect disassembly

The following risks may result through incorrect disassembly:

- Injury through electric shock
 - Risk through emerging media when connected to the process
 - Risk of explosion in hazardous area
-

In order to disassemble correctly, observe the following:

- Before starting work, make sure that you have switched off all physical variables such as pressure, temperature, electricity etc. or that they have a harmless value.
- If the device contains hazardous media, it must be emptied prior to disassembly. Make sure that no environmentally hazardous media are released.
- Secure the remaining connections so that no damage can result if the process is started unintentionally.



5. Electrical Installation

5.1. Basic Safety Notes

WARNING!**Energized devices**

Risk of electric shock or explosion.

When energized the device may be opened by qualified personnel only.

WARNING!**Mains supply from building installation overvoltage category 2**

A switch or circuit breaker (max. 15 A) must be installed in close proximity to the equipment and within easy reach of the operator. It must be marked as the disconnecting device for the equipment.

WARNING!**Missing PE/ground connection**

Risk of electric shock.

Depending on the device version, connect the power supply as follows:

- Power plug: Ensure that the used socket has a PE/ground conductor connection. Check that the PE/ground conductor connection of the socket and power plug match each other.
 - Connecting terminals: Connect the terminals according to the terminal connection diagram. First connect the PE/ground conductor.
-

WARNING!**Unsuitable cables, cable glands and/or plugs**

Risk of explosion in hazardous areas.

Use only cable glands/plugs that comply with the requirements for the relevant type of protection.

Tighten the cable glands in accordance with the torques specified in "Technical Data" (chapter 11, page 157).

Close unused cable inlets for the electrical connections.

When replacing cable glands use only cable glands of the same type.

After installation check that the cables are seated firmly.

WARNING!**Incorrect conduit system**

Risk of explosion in hazardous areas as result of open cable inlet or incorrect conduit system.

In the case of a conduit system, mount a spark barrier at a defined distance from the device input. Observe national regulations and the requirements stated in the relevant approvals.



WARNING!**Hazardous contact voltage**

Risk of electric shock in case of incorrect connection.

For the electrical connection specifications, refer to the information in "Technical Data" (chapter 11, page 157).

At the mounting location of the device observe the applicable directives and laws for installation of electrical power installations with rated voltages below 1,000 V.

NOTE:**Condensation in the device**

Damage to device through formation of condensation if the temperature difference between transportation or storage and the mounting location exceeds 20 °C [68 °F].

Before taking the device into operation let the device adapt for several hours in the new environment.

NOTE:**Ambient temperature too high**

Damage to cable sheath.

At an ambient temperature ≥ 60 °C [140 °F], use heat-resistant cables suitable for an ambient temperature at least 20 °C [68 °F] higher

WARNING!**Improper power supply**

Risk of explosion in hazardous areas as result of incorrect power supply, e.g. using direct current instead of alternating current.

Connect the device in accordance with the specified power supply and signal circuits. The relevant specifications can be found in the certificates, in "Technical Data" (chapter 11, page 157) or on the nameplate.

WARNING!**Unsafe extra-low voltage**

Risk of explosion in hazardous areas due to voltage flashover.

Connect the device to an extra-low voltage with safe isolation (SELV).

WARNING!**Lack of equipotential bonding**

Risk of explosion through compensating currents or ignition currents through lack of equipotential bonding.

Ensure that the device is potentially equalized.

Exception: It may be permissible to omit connection of the equipotential bonding for devices with type of protection "Intrinsic safety Ex i".

WARNING!**Unprotected cable ends**

Risk of explosion through unprotected cable ends in hazardous areas.

Protect unused cable ends in accordance with IEC/EN 60079-14.



WARNING!**Improper laying of shielded cables**

Risk of explosion through compensating currents between hazardous area and the non hazardous area.
Shielded cables that cross into hazardous areas should be grounded only at one end.
If grounding is required at both ends, use an equipotential bonding conductor.

WARNING!**Uncovered non-intrinsically safe circuits**

Risk of explosion in hazardous areas or electric shock when working on non-intrinsically safe circuits.
If intrinsically safe and non-intrinsically safe circuits are operated in an enclosure with the type of protection "Increased safety Ex e", the connections of the non-intrinsically safe circuits must be additionally covered.
Ensure that the cover of the non-intrinsically safe circuits complies with degree of protection IP30 or higher according to IEC/EN 60529.
Separate connections of the non-intrinsically safe circuits in accordance with IEC/EN 60079-14.

WARNING!**Insufficient isolation of intrinsically safe and non-intrinsically safe circuits**

Risk of explosion in hazardous areas.
When connecting intrinsically safe and non intrinsically safe circuits ensure that isolation is carried out properly in accordance with local regulations for example IEC 60079-14.
Ensure that you observe the device approvals applicable in your country.

WARNING!**Connecting device in energized state**

Risk of explosion in hazardous areas.
Connect devices in hazardous areas only in a de-energized state.

Exceptions:

- Devices having the type of protection "Intrinsic safety Ex i" may also be connected in energized state in hazardous areas.
 - Exceptions for type of protection "Non-sparking nA" (Zone 2) are regulated in the relevant certificate.
-

WARNING!**Incorrect selection of type of protection**

Risk of explosion in areas subject to explosion hazard.
This device is approved for several types of protection.

1. Decide in favor of one type of protection.
2. Connect the device in accordance with the selected type of protection.
3. In order to avoid incorrect use at a later point, make the types of protection that are not used permanently unrecognizable on the nameplate.



NOTE:**Electromagnetic compatibility (EMC)**

You can use this device in industrial environments, households and small businesses.

For metal housings there is an increased electromagnetic compatibility compared to high-frequency radiation. This protection can be increased by grounding the housing, see section “Electrical Installation” (chapter 5, page 40).

NOTE:**Improvement of interference immunity**

Lay signal cables separate from cables with voltages > 60 V.

Use cables with twisted wires.

Keep device and cables at a distance from strong electromagnetic fields.

Take account of the conditions for communication specified in the “Technical Data” (chapter 11, page 157).

HART: Use shielded cables to guarantee the full specification according to HART.

Use in hazardous areas

Before accessing the sensor terminal compartment and application terminal space check that:

- A safe access permission certificate has been issued by plant operations management
- The flow transmitter may not be opened if energized
- All connection leads are potential free

WARNING!**Hazardous areas**

Observe the type examination certificates or the test certifications applicable in your country if you use transmitters as category 1/2 equipment.

WARNING!**Commissioning**

Only apply power and commission the device after the device has been properly connected and, if required, closed.



5.2. Connecting the Transmitter

This chapter describes how to wire up the device.

The following steps must be carried out:

- Connecting the transmitter without display (TCD 9010) (chapter 5.2.2.1, page 45)
- Preparing the connections for transmitters with display (TCD 9100, TCD 9200) (chapter 5.2.2.2, page 48)
- Connect the device to a process control system:
 - Connecting the Current HART, CH1 (chapter 5.2.2.3, page 51)
 - Connecting the Modbus (CH1) (chapter 5.2.2.4, page 52)
 - Connecting the Profibus (CH1) (chapter 5.2.2.5, page 53)
- Connecting the Power Supply to transmitters with display (chapter 5.2.2.8, page 56)
- Finishing the Transmitter Connection (chapter 5.2.2.9, page 57)

5.2.1. Cable Requirements

Cable specifications

- When installing sensor cable, use cable with at least same degree of protection as the sensors. It is recommended to use cables supplied:
 - blue cables for installation of intrinsically safe circuits in hazardous areas
 - gray cables for installation of non-intrinsically safe circuits

Further information on supplied cables, see “Cables and Cable Entries” (chapter 11.6.2, page 163).

- The wire length inside the connection compartment, from the cable gland to the terminals, must be kept as short as possible. Wire loops in the terminal compartment must be avoided.
- To guarantee the degree of ingress protection, ensure that both ends of the cables are given equivalent protection from ingress of moisture.

WARNING!

Cable requirements

Cables must be suitable for the process temperature (at least 70 °C [158 °F]) and be flammability-rated to at least V-2.

NOTE:

Output cables

If long cables are used in noisy environments, it is recommended to use shielded cables.



5.2.2. Transmitter Power Supply and I/Os Connection

5.2.2.1. Connecting the TCD 9010 and the Link Module TCD 9200

Electrical installation

The TCD 9010 transmitters are supplied with a 4-pin M12 plug socket or with a cable gland.

The TCD 9200 is provided with a preformed cable terminated with M12 style stainless steel weather-proof plug.

The cable screen is physically and electrically terminated within the body of the plug.

Take care when handling the cable and passing it through cable ducting that the plug is not subjected to excessive tension (pulling) as the internal connections may be disengaged.

NOTE:

Never pull the cable by the plug – only by the cable itself.

Connect TCD 9200 (Link Module and transmitter with display) using the supplied 4-wire cable with M12 connectors.

NOTE:

Grounding

The TCD 9200 cable screen is mechanically connected to the grounding terminal (PE), only when the M12 plug is correctly tightened.

Wiring the transmitters (TCD 9010 with cable gland)

Prepare the cable by stripping it at both ends.

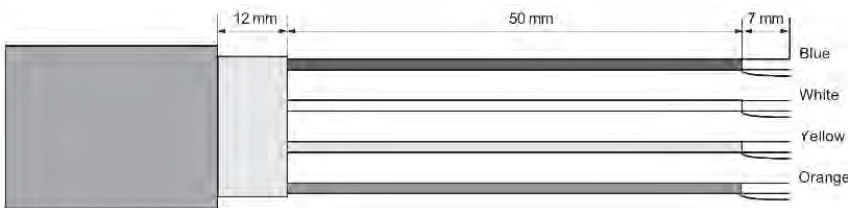

Fig. 27: Cable end



Connecting sensor TCD 9010

1. Remove lock screw of the housing cover and the lid.
2. Undo the flexible strap.
3. Disconnect sensor connection from TCD 9010 housing.
4. Loosen mounting screw using a TX10 Torx driver and remove TCD 9010 electronic cassette from housing.
5. Remove cap and ferrule from cable gland and slide onto cable.
6. Push cable through open gland; anchor cable screen and wires with clamp bar.
7. Remove terminal block from TCD 9010 cassette.
8. Connect wires to terminals according to list below.

Terminal number	Description	Wire color (TRICOR cable or M12 plug socket)
1	0+	Orange
2	0 V	Yellow
3	RS485 / B	White
4	RS485 / A	Blue

Tab. 9: Connections TCD 9010 and Link Module of the TCD 9200 transmitter



Fig. 28: Electrical terminals TCD 9010

9. Ensure the DIP switches are all set to **OFF** for TCD 9010 and the Link Module of the TCD 9200.
10. Reinstall TCD 9010 cassette including mounting screw.
11. Connect sensor connection and sensor cable plugs.
12. Restore flexible strap around all wires.

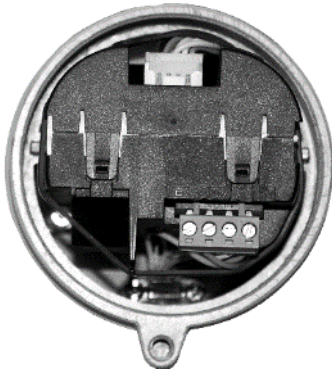

Fig. 29: Flexible strap TCD 9010 transmitter

13. Assemble and tighten cable gland.
14. Remove O-ring from TCD 9010.
15. Reinstall lid and screw in until mechanical stop. Wind back lid by one turn.
16. Mount O-ring by pulling it over the TCD 9010 lid and tighten lid until you feel friction from the O-ring on both sides. Wind lid further by one quarter of a turn to seal on the O-ring.
17. Reinstall and tighten lid lock screw.
18. Close and secure TCD 9010 lid including lock screw. Turn the lid until you can feel the friction of the O-ring. From this point turn the lid $\frac{1}{4}$ turn to be tight.



5.2.2.2. Preparing the Connections for the Transmitters with Display (TCD 9100 and TCD 9200)

WARNING!

Access to terminal compartment

As long as the device is energized, the lid of the housing on the sensor connection area may only be opened by qualified personnel.

Before removing the terminal cover, the auxiliary power must be switched off.

Following installation, the terminal cover must be screwed back on again.

1. Remove blind plugs where required and mount cable glands.

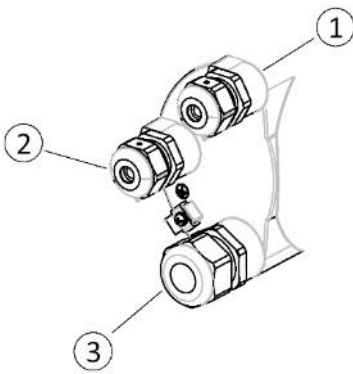

- ① Input/output connection (channels 2 to 4)
- ② Power supply connection
- ③ Current output/communication outputs (channel 1)

Fig. 30: Electrical terminals TCMQ

2. Remove lid lock screw for terminal connections lid.
3. Remove lid for terminal connections.

A label showing the configuration is placed at the back of the terminal connections lid.

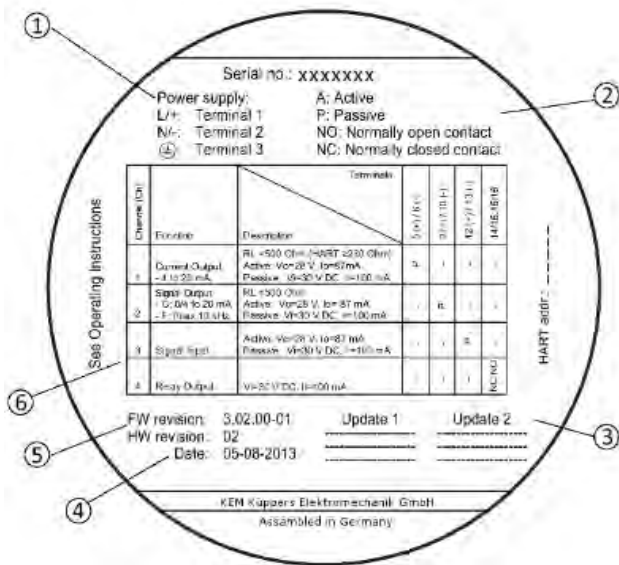

Fig. 31: Configuration label

- ① Power supply connections
 - L/+ Terminal 1
 - N/- Terminal 2
 - ⊕ Terminal 3
- ② Key to symbols
 - A Configured as active input/output
 - P Configured as passive input/output
 - NO Connected as normally open contact
 - NC Connected as normally close contact
- ③ Updates (to be filled in on firmware and hardware updates)
- ④ Device configuration date
- ⑤ Initial firmware and hardware revisions
- ⑥ Configuration of channels 1, 2, 3 and 4

Terminal layout

Transmitter with display (TCD 9100 and TCD 9200)

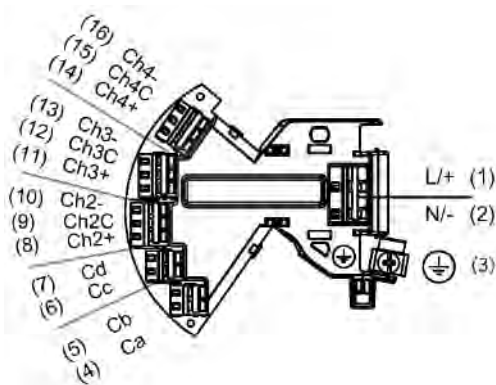

Fig. 32: Terminal layout



For configuration of the inputs/outputs, see table in section “Connecting I/O-channels 2 to 4” (chapter 5.2.2.6, page 53).

The following table shows:

- Which cable with which terminal
- Hardware and software configuration of the channels

HW configuration	SW configuration	Terminals																		
		Power Supply			Channel 1				Channel 2			Channel 3			Channel 4					
		1	2	3	4	5	6	7	8	9	10	11	12	13	14	15	16			
Power Supply		L/+	N/-	⊕																
Channel 1 HART	Current output HART				+ Active	Common														
Channel 1 Modbus					Common	+ Passive														
Channel 1 Profibus					In-A	In-B														
Channel 2 Output	Current, Frequency, Pulse and Status						Out-A	Out-B												
Channels 3 and 4 Input/output	Outputs: Current, Frequency, Pulse and status Inputs: Digital								+ Active	Common			+ Active	Common			+ Active	Common		
Channels 3 and 4 Relay	Status output										Common	+ Passive								
													NC					NC		
															NO					NO

Fig. 33: Termination/configuration overview

Wiring tool

Use the wiring tool for connecting the cables in the compact housing transmitter.

The wiring tool is located in the application terminal compartment.

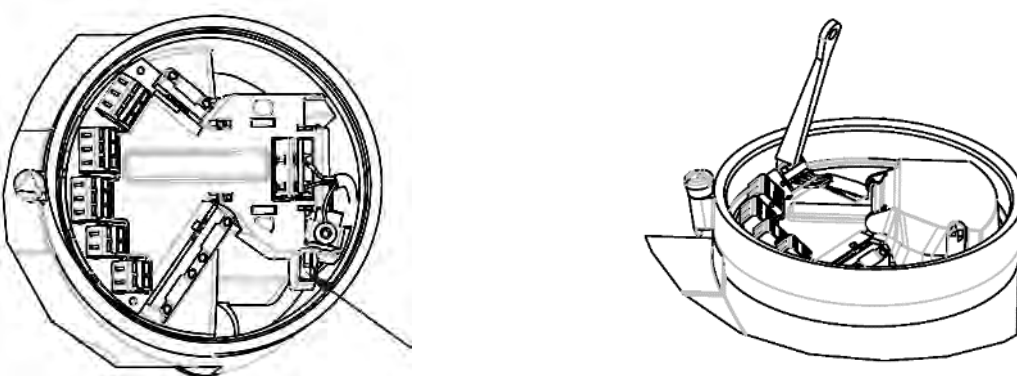

Fig. 34: Wiring tool location

1. Insert wiring tool hook into receptor slot.
2. Press wiring tool wedge into top slot to spread clamp plates.
3. Insert wire.
4. Release wiring tool.



5.2.2.3. Connecting the Current HART, CH1

NOTE:

4 to 20 mA output

It is not required to use shielded cables for the pure 4 to 20 mA current output.

NOTE:

HART communication

It is recommended by the FieldComm Group (FCG) to use shielded cables for the HART communication.

NOTE:

Passive channels only

Channel 1 power supply must be separated from that for channels 2 to 4.

Signal return (or common) can be joined.

1. Remove cap and ferrule from cable gland and slide onto cable.
2. Push cable through open gland and cable path.
3. Restore ferrule and tighten cap to lightly hold cable in place.
4. Signal cable screen is folded back over outer sheath and grounded beneath cable clamp.
5. Connect wires to terminals using wiring tool, field mount transmitter
6. Tighten cable gland.

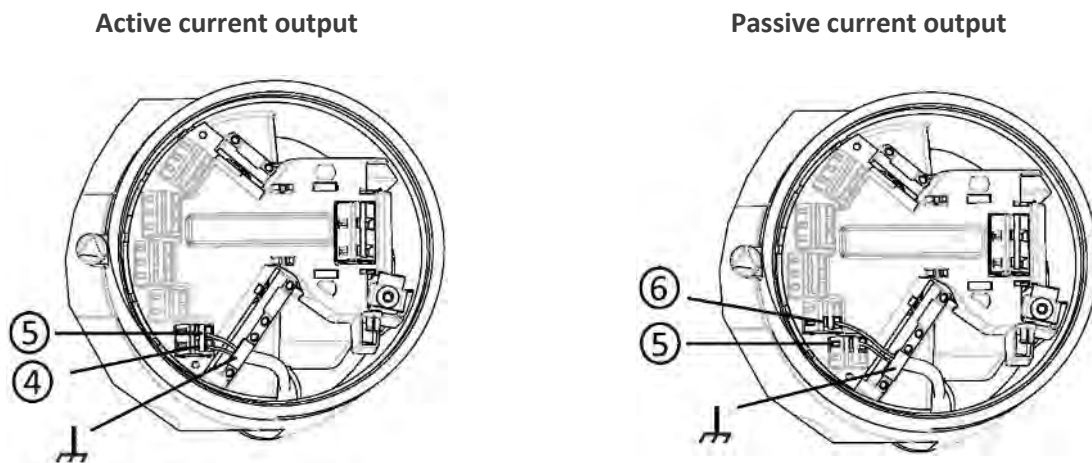
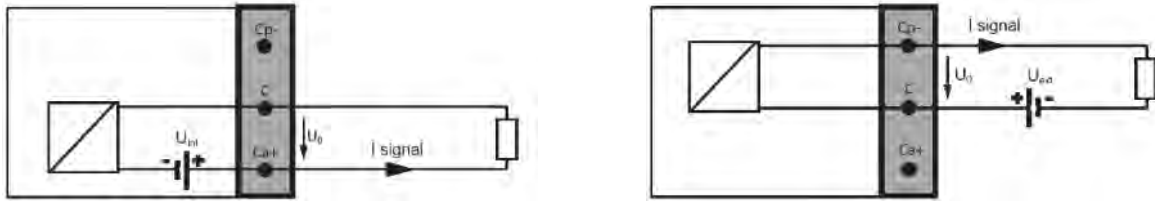

Fig. 35: Connecting the Current HART, CH1

⑤ C
 ④ Ca+
 ⚡ Functional Earth

⑥ Cp-
 ⑤ C
 ⚡ Functional Earth



NOTE:

For Ex versions active or passive current output is preselected at ordering and cannot be changed.

Non-Ex versions can be connected as either active or passive.

NOTE:

Load

Signal output: < 500 Ω at 14 to 24 V DC (active), 14 to 30 V DC (passive)

Relay output: 30 V AC/V DC, 100 mA

Passive signal input: 15 to 30 V DC, 2 to 15 mA

5.2.2.4. Connecting the Modbus (CH1)

1. Remove cap and ferrule from cable gland and slide onto cable.
2. Push cable through open gland and cable path.
3. Restore ferrule and tighten cap to lightly hold cable in place.
4. Signal cable screen is folded back over outer sheath and grounded beneath cable clamp.
5. Connect wires to terminals using wiring tool, field mount transmitter

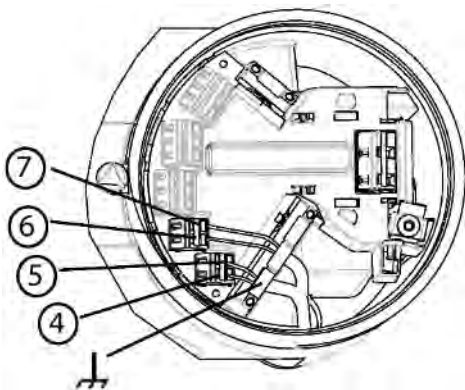

Modbus

- ④ In + (B)
- ⑤ In - (A)
- ⑥ Out + (B)
- ⑦ Out - (A)

⌋ Functional Earth

Fig. 36: Connecting the Modbus (CH1)



5.2.2.5. Connecting the Profibus (CH1)

WARNING!

Passive channels only

Channel 1 power supply must be separated from that for channels 2 to 4.

Signal return (or common) can be joined.

1. Remove cap and ferrule from cable gland and slide onto cable.
2. Push cable through open gland and cable path.
3. Restore ferrule and tighten cap to lightly hold cable in place.
4. Signal cable screen is folded back over outer sheath and grounded beneath cable clamp.
5. Connect wires to terminals using wiring tool, field mount transmitter

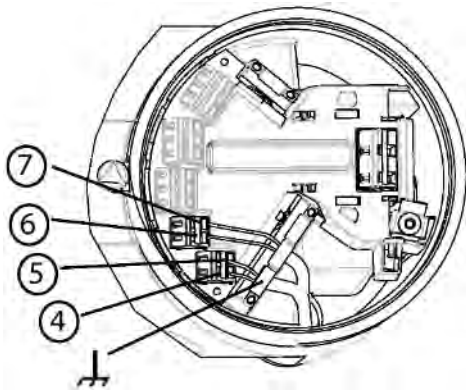

PROFIBUS DP/PA

- ④ In + (B)
- ⑤ In - (A)
- ⑥ Out + (B)
- ⑦ Out - (A)

⏏ Functional Earth

Fig. 37: Connecting the Profibus (CH1)

5.2.2.6. Connecting I/O-channels 2 to 4

Channel 2 is for output only and channels 3 to 4 can be connected as either inputs/outputs or relays, see "Input/Output Configuration" (chapter 5.2.2.7, page 54).

Connect wires

1. Remove cap and ferrule from cable gland and slide onto cable.
2. Push cable through open gland and cable path.
3. Restore ferrule and tighten cap to lightly hold cable in place.
4. Fold signal cable screen back over outer sheath and ground beneath cable clamp.
In case of shielded cables, use metal cable glands for proper connection.
5. Connect wires to terminals using screwdriver.
6. Tighten cable gland.

The numbers in the graphics below refer to table Termination/configuration overview (Fig. 35, page 50).



If connected as input or output – Transmitter with display (TCD 9*00)

Active configuration

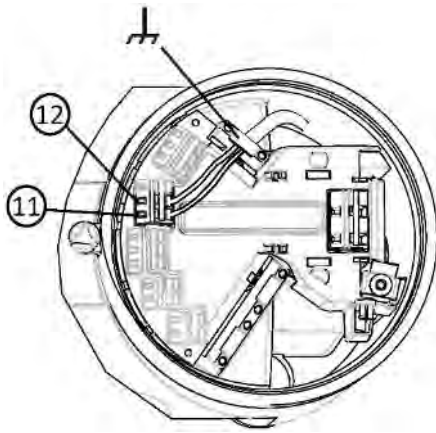

Passive configuration

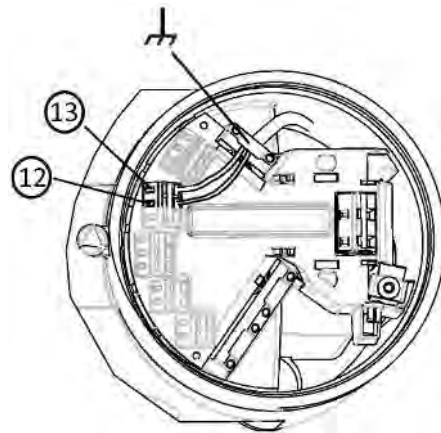

Fig. 38: Connecting I/O-channels 2 to 4

⑫ IO[3] (common)

⑪ IO[3]+ (active)

⏏ Functional Earth

⑬ IO[3]- (passive)

⑫ IO[3] (common)

⏏ Functional Earth

5.2.2.7. Input/Output Configuration

Configuration	Software configuration	Channel			
		2	3	4	
Output Active	Current output Frequency output Pulse output Digital output <ul style="list-style-type: none"> Alarm class Alarm item NAMUR status signals 	X	X	X	<p>Active</p>
Output Passive	Current output Frequency output Pulse output Digital output <ul style="list-style-type: none"> Alarm class Alarm item NAMUR status signals 	X	X	X	<p>Passive</p>



Configuration	Software configuration	Channel			
		2	3	4	
Input Active	Digital input <ul style="list-style-type: none"> Reset totalizer 1 Reset totalizer 2 Reset totalizer 3 Reset all totalizers Force outputs Freeze process values Zero adjust 		X	X	<p>Active</p>
Input Passive	Digital input <ul style="list-style-type: none"> Reset totalizer 1 Reset totalizer 2 Reset totalizer 3 Reset all totalizers Force outputs Freeze process values Zero adjust 		X	X	<p>Passive</p>
Relay Output Normally open	Alarm class Alarm item NAMUR status signals		X	X	<p>Normally open</p>
Relay Output Normally closed	Alarm class Alarm item NAMUR status signals		X	X	<p>Normally closed</p>

Tab. 10: Input/output configuration



5.2.2.8. Connecting the Power Supply (transmitter with display)

1. Remove wiring tool and flip open power supply terminal protection cover.
2. Remove cap and ferrule from cable gland and slide onto cable.
3. Push cable through open gland and cable path.

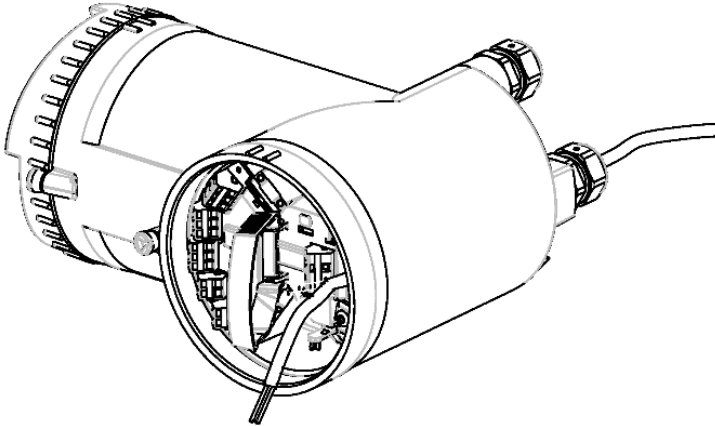

Fig. 39: Open power supply terminal

4. Restore ferrule and tighten cap to lightly hold cable in place.
5. Connect ground to terminal \ominus and power to terminals L/+ and N/- using wiring tool in the manner shown in Fig. 40.

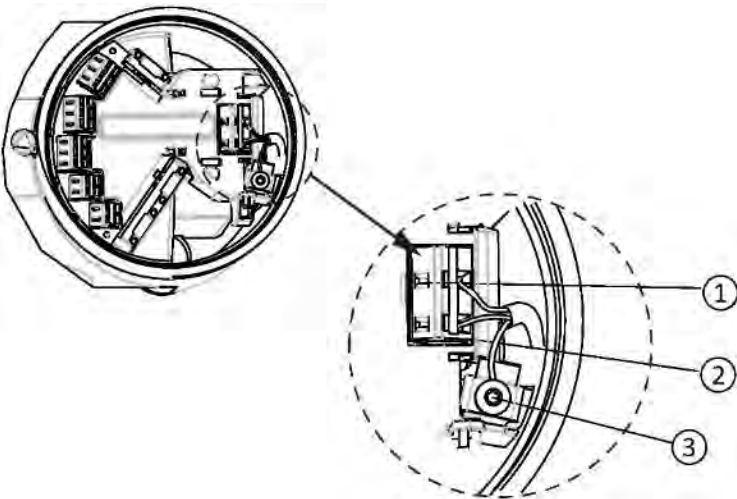
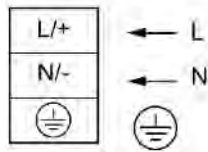

Fig. 40: Connect ground and power

- ① L/+
- ② N/-
- ③ \ominus Protective Earth (PE)



AC connection



Power: 100 to 240 V AC, 47 to 63 Hz

DC connection

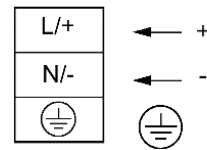

Power: 19.2 to 28.8 V DC

6. Close and latch power supply terminal protection cover.
7. Tighten cable gland.

5.2.2.9. Finishing the transmitter connection

Connection check-up

1. Check individual wire installation by tugging firmly.
2. Firmly tighten cable glands and insert blanking plugs in unused cable entries.
3. Close lid.
4. Tighten the four spring screws.
5. Ensure that moisture does not penetrate to inside of electronics enclosure.

Your device is now ready for commissioning.

5.3. Wiring Information

5.3.1. Wiring in Hazardous Areas

Hazardous area applications

Special requirements apply to the location and interconnection of sensor and transmitter. See “Installation in Hazardous Areas” (chapter 2.4.3, page 14).

WARNING!

Transmitter housing

Before opening the terminal box check that:

- No explosion hazard exists
 - All connection leads are potential free
-



5.4. Device Nameplates

5.4.1. Device Identification

Each part of the TRICOR Coriolis Flow Meter has three nameplate types showing the following information:

- product identification
- product specifications
- certificates and approvals

NOTE:**Identification**

Identify your device by comparing your ordering data with the information on the product and specification nameplates.

With compact versions, the transmitter and sensor product identifications are both given as 'Coriolis flowmeter TCMQ'.

With remote versions, the transmitter is identified as 'Coriolis transmitter TCD 9*00' and the sensor as 'Coriolis sensor TCMQ'.



TCD 9*00 transmitter identification nameplate

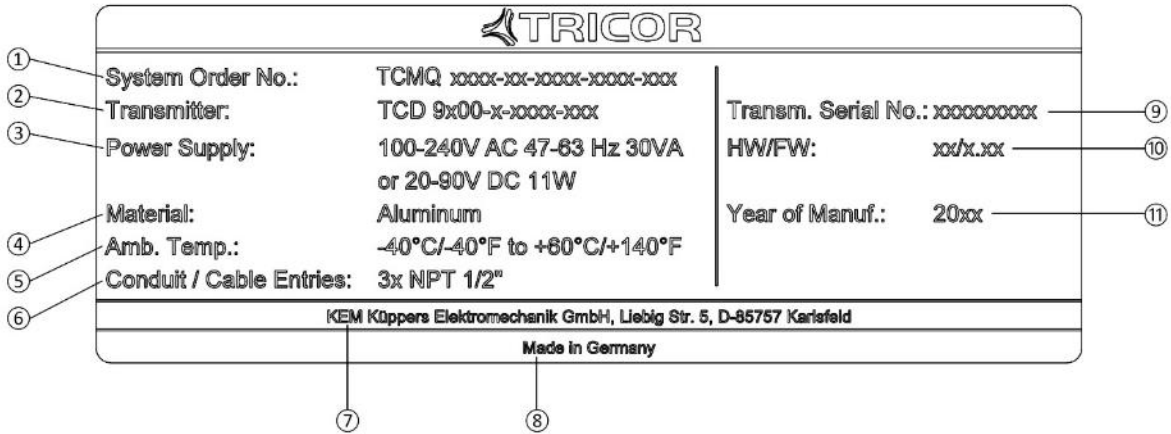

Fig. 41: Identification nameplate

①	System Order Number	Product name of the measuring instrument (transmitter and sensor)
②	Transmitter	Ordering code transmitter
③	Power Supply	Power supply
④	Material	Transmitter housing material
⑤	Amb. Temp.	Ambient temperature
⑥	Conduit/cable entries	Type of conduit/cable entries
⑦	Manufacturer	Manufacturer name and location
⑧	Country	Manufacturing country
⑨	Serial no.	Serial number of the device/transmitter
⑩	HW/FW	System revision numbers; firmware (FW) and hardware (HW)
⑪	Year of Manuf.	Manufacturing year



TCMQ sensor identification nameplate

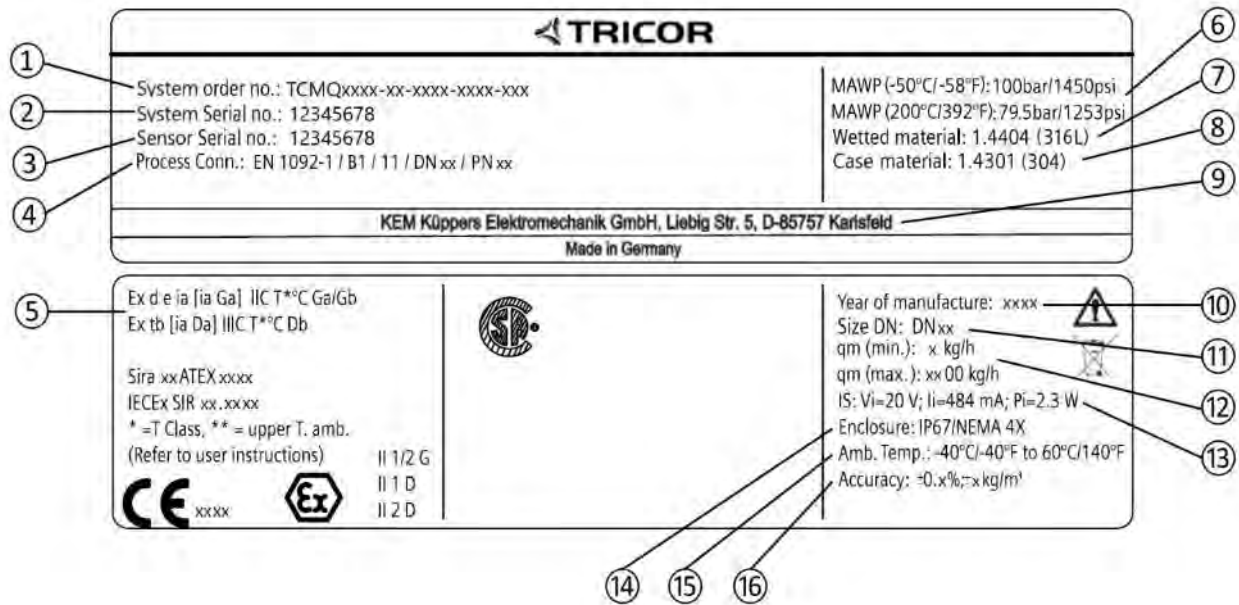

Fig. 42: TCMQ sensor identification nameplate

- | | | |
|---|---------------------|---|
| ① | System order no. | Device-specific order number (transmitter and sensor) |
| ② | System Serial no. | System serial number (sensor and transmitter) |
| ③ | Sensor Serial no. | Sensor serial number |
| ④ | Process Conn. | Process connection |
| ⑤ | Ex-Zulassungen | Ex approval specifications for the transmitter (ATEX example; for details on all approvals refer to "Bus Communication" (chapter 11.9, page 166) <i>(if applicable)</i>) |
| ⑥ | MAWP | Maximum allowable operating pressure |
| ⑦ | Wetted material | Material for wetted parts |
| ⑧ | Case material | Material of the meter |
| ⑨ | Manufacturer | Manufacturer name and location, country of production |
| ⑩ | Year of manufacture | Manufacturing year |
| ⑪ | Size DN | Nominal pipeline diameter |
| ⑫ | qm (min./max.) | Minimal/maximal mass flow |
| ⑬ | IS | Electrical connected loads of the sensor |
| ⑭ | Enclosure | Ingress protection |
| ⑮ | Amb. Temp. | Temperature rating, ambient |
| ⑯ | Accuracy | Accuracy rating |



TCD 9*00 transmitter specification nameplate

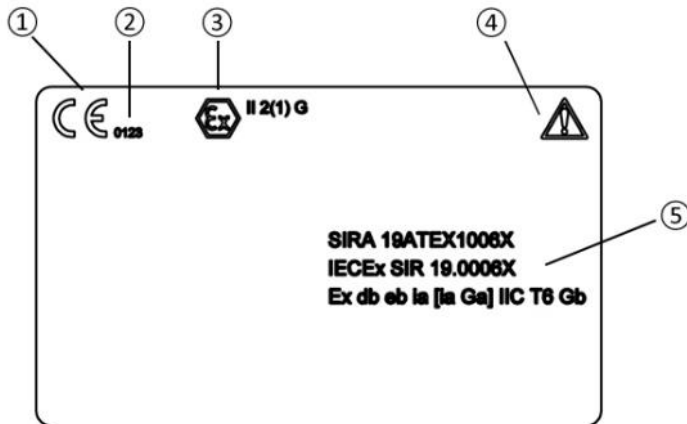

Fig. 43: TCD 9*** transmitter specification nameplate

①	CE	CE mark
②	0123	ATEX Notified Body ID (SIRA Certification)
③	Ex	Ex mark, see “Installation in Hazardous Areas” (chapter 2.4.3, page 14) <i>(if applicable)</i>
④	⚠	Consult the operating instructions
⑤	Ex approvals	Ex approval specifications for the transmitter (ATEX example; for details on all approvals refer to “Bus Communication” (chapter 11.9, page 166) <i>(if applicable)</i>

NOTE:

Approval identifications

Approval certificates and notified body identifications are available for download at www.tricorflow.com.



TCD 9*** transmitter approval nameplate

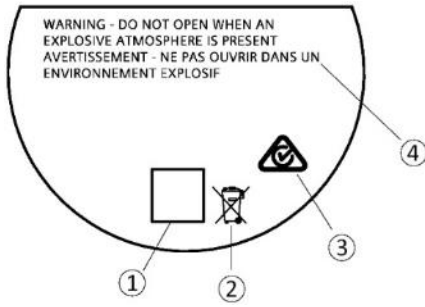

Fig. 44: TCD 9*** transmitter approval nameplate

- | | | |
|---|------------|---|
| ① | QR code | Product-specific QR code <i>(if applicable)</i> |
| ② | | WEEE symbol, see “Disposal” (chapter 9.7, page 133) |
| ③ | C✓ | C-tick logo <i>(if applicable)</i> |
| ④ | FORCE OIML | Custody Transfer evaluation certificate number <i>(if applicable)</i> |

TCMQ sensor approval nameplate *(if applicable)*

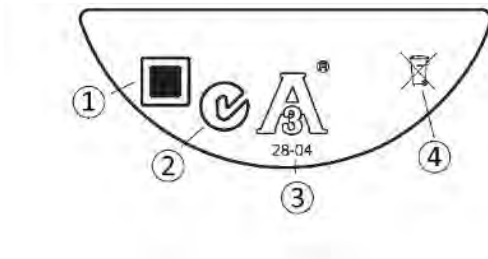

Fig. 45: TCMQ sensor approval nameplate

- | | | |
|---|---------|---|
| ① | QR code | Product-specific QR code <i>(if applicable)</i> |
| ② | C✓ | C-tick logo <i>(if applicable)</i> |
| ③ | 3A | 3A logo <i>(if applicable)</i> |
| ④ | | WEEE symbol, see “Disposal” (chapter 9.7, page 133) |

NOTE:

Logos and warnings

Logos and warnings are only shown on the product where applicable. The combination shown in the example above is relevant for a hygienic sensor installed in hazardous area in Canada.



6. Commissioning

In this chapter it is described how to commission the device via the local display using the Quick commissioning wizard.

6.1. Basic Safety Notes

WARNING!

Improper commissioning in hazardous areas

Device failure or risk of explosion in hazardous areas.

Do not commission the device until it has been mounted completely and connected in accordance with the information in “Installing/Mounting” (chapter 4, page 27).

Before commissioning take the effect on other devices in the system into account.

WARNING!

Hot surfaces

Risk of burns resulting from hot surfaces.

Take corresponding protective measures, for example by wearing protective gloves.

NOTE:

Hot surface is only an issue for media or ambient temperature above 50 °C [122 °F].

CAUTION!

Loss of type of protection

Damage to device if the enclosure is open or not properly closed.

The type of protection specified on the nameplate or in “Sensor Design” (chapter 11.6.1, page 162) is no longer guaranteed.

Make sure that the device is securely closed.

WARNING!

Hazardous contact voltage

Risk of injury through hazardous contact voltage when the device is open or not completely closed.

The degree of protection specified on the nameplate or in “Technical Data” (chapter 11, page 157) is no longer guaranteed if the device is open or not properly closed.

Make sure that the device is securely closed.

DANGER!

Toxic gases and liquids

Danger of poisoning when venting the device: if toxic process media are measured, toxic gases and liquids can be released.

Before venting ensure that there are no toxic gases or liquids in the device, or take the appropriate safety measures.



WARNING!**Loss of explosion protection**

Risk of explosion in hazardous areas if the device is open or not properly closed.

Close the device as described in "Installing/Mounting" (chapter 4, page 27).

WARNING!**Opening device in energized state**

Risk of explosion in hazardous areas.

Only open the device in a de-energized state.

Check prior to commissioning that the cover, cover locks, and cable inlets are assembled in accordance with the directives.

Exception: Devices having the type of protection "Intrinsic safety Ex i" may also be opened in energized state in hazardous areas.

6.1.1. Warnings

WARNING!**Dangerous high voltage**

Certain parts inside the device carry dangerous high voltage. The housing must be closed and grounded before switching on the device.

WARNING!**Improper handling**

The sensor connected to this device can be operated with high pressure and corrosive media. Therefore improper handling of the device can lead to serious injuries and/or considerable material damage.

6.2. General Requirements

Before commissioning it must be checked that:

- The device has been installed and connected in accordance with the guidelines provided in "Installing/Mounting" (chapter 4, page 27) and "Electrical Installation" (chapter 5, page 40).
- Device installed in hazardous areas meets the requirements described in "Use in Hazardous Areas" (chapter 2.4, page 12).



6.3. Commissioning Assistants

The local display (HMI) provides the user with comprehensive information on the operation and status of the flow meter.

This chapter provides information on how to monitor and operate the device using the local display.

6.3.1. Operation of the display/HMI

The device is operated with the capacitive proximity keys of the local user interface.

The elements are operated by touching the glass panel above the corresponding key. The glass is 10 mm thick ($\frac{3}{8}$ ""). Pressing the key harder will not activate it, but using a thumb instead of a fingertip will help. The text display above the control elements gives a menu-guided operation of the respective device functions/parameters. Successful operation of the key is confirmed by a small green LED at the right of the display.

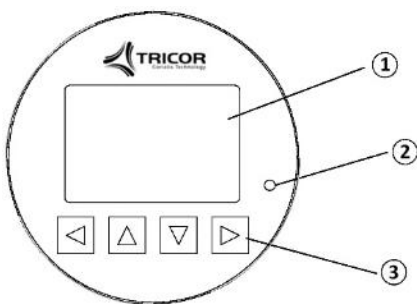

- ① Full graphical display
- ② LED (for indication of key operation)
- ③ Kex elements

Fig. 46: Design of the display/HMI

NOTE:

(Re-)calibration of the keypad

When the lid is closed, all keys are (re-)calibrated (< 5 seconds). During (re-)calibration the LED is on and the keys cannot be operated.

If one of the keys is pressed for more than 10 seconds, the (re-)calibration of this key begins which has a duration of less than 10 seconds. Release the key for further operation.

NOTE:

timeout

If no key is pressed for 10 minutes, the display switches to show operation view. If Backlight is set to Automatic, display backlight goes off automatically 30 seconds after the last keypress.

NOTE:

Operation does not require opening of the device. This means that the high degree of protection of IP67 and safety in hazardous areas are guaranteed at all times.



6.3.2. Commissioning via HMI

6.3.2.1. Wizard Introduction

In this chapter it is described how to commission the device via the local display (HMI) using the Quick Commissioning wizard. For further information on how to navigate the wizards, refer to “Quick Commissioning Wizard (menu item 1.1)” (chapter 6.3.2.2, page 67).

In the wizard graphics below, the HMI view numbers are stated to the left.

The first view in each wizard (About - view 1) is a description of what settings/actions can be performed using the specific wizard. The last view in each wizard (Finished) shows that the last step of the wizard was completed. Any parameter changes confirmed with are saved immediately.

At any time in any wizard selecting Exit will bring you back to the main wizard menu without discarding changes.

The first time the device is powered up, you will be prompted to set the language. The device always starts up showing Language in English. When the language has been set, you will be prompted to set the date and time.

After confirming/changing the date and time you will be asked if you want to start the Quick Commissioning wizard. If you choose Yes (recommended), the Quick Commissioning wizard will start. If you choose No, you accept the default values of the device, and the next HMI view will be the operation view 1.

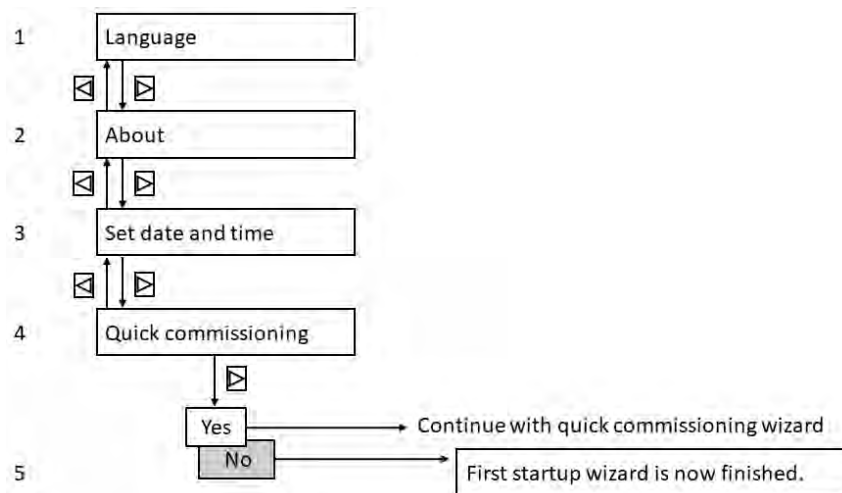

View no.	Text	Options/Description
1	Language	Set the language: English, Deutsch, Français, Italiano, Español, 汉语
2	About	Information about the Quick Commissioning wizard
3	Set Date and Time	The set date and time (real time clock) is used for all time stamps of logged information
4	Quick Commissioning	The Quick Commissioning wizard comprises the most important parameters/menus for quick configuration of the flow meter



6.3.2.2. Quick Commissioning Wizard (menu item 1.1)

The Quick Commissioning wizard will guide you through configuration of parameters essential for your application. You configure parameters essential for your application by selecting the configuration path and subwizards appropriate for your application.

See also

- Process Values Wizard (menu item 1.3) (chapter 6.3.2.5, page 70)
- Gas Application Wizard (menu item 1.5) (chapter 6.3.2.7, page 75)
- Pulsating Flow Wizard (menu item 1.6) (chapter 6.3.2.8, page 76)
- Dosing Application Wizard (menu item 1.7) (chapter 6.3.2.9, page 77)
- Zero Point Adjustment Wizard (menu item 1.2) (chapter 6.3.2.4, page 68)
- Inputs/Outputs Wizard (menu item 1.4) (chapter 6.3.2.6, page 71)

6.3.2.3. Zero Point Adjustment

The flow meter system is optimized through a zero point adjustment which is performed via wizard.

Performing a zero point adjustment

CAUTION!

Gas application

Zero point adjusting the device is only recommended for liquid applications.

1. Flush out any gases and obtain stable temperature conditions by running flow at operational conditions (pressure and temperature) for minimum 30 minutes.

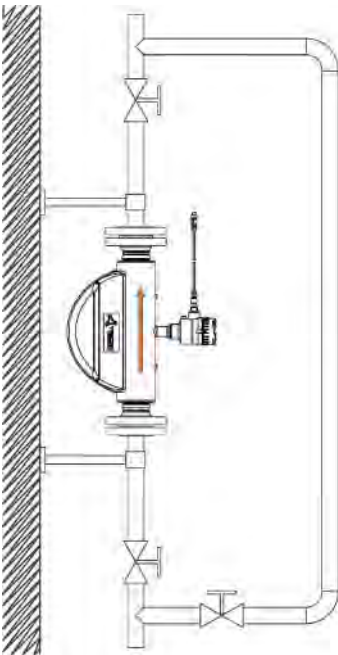

Fig. 47: Best practice zero point adjustment with a bypass line and two shut-off devices



2. Close the outlet shut-off valve while maintaining the system pressure. If bypass flow is necessary, open the bypass valve. If the pressure can be increased by 1 to 2 bars with stopped flow, this should be applied.
3. Wait 1 to 2 minutes, for the system to settle, and then perform zero adjustment. Waiting longer can change the temperature.
4. During the process a progress bar is visible in the HMI display.
5. At the end of the zero adjustment, the outcome is displayed as an offset and a standard deviation.

NOTE:

If you get an error message after the zero point adjustment, refer to “Zero Point Adjustment” (chapter 6.3.2.3, page 67).

6.3.2.4. Zero Point Adjustment Wizard (menu item 1.2)

The flow meter system is optimized through an automatic zero point adjustment. Before you start the zero point adjustment flush the pipe and keep it filled at an absolute flowrate of zero. Ensure that the sensor has the same temperature as the process media. Perform at operating pressure or at least 0.2 bar.

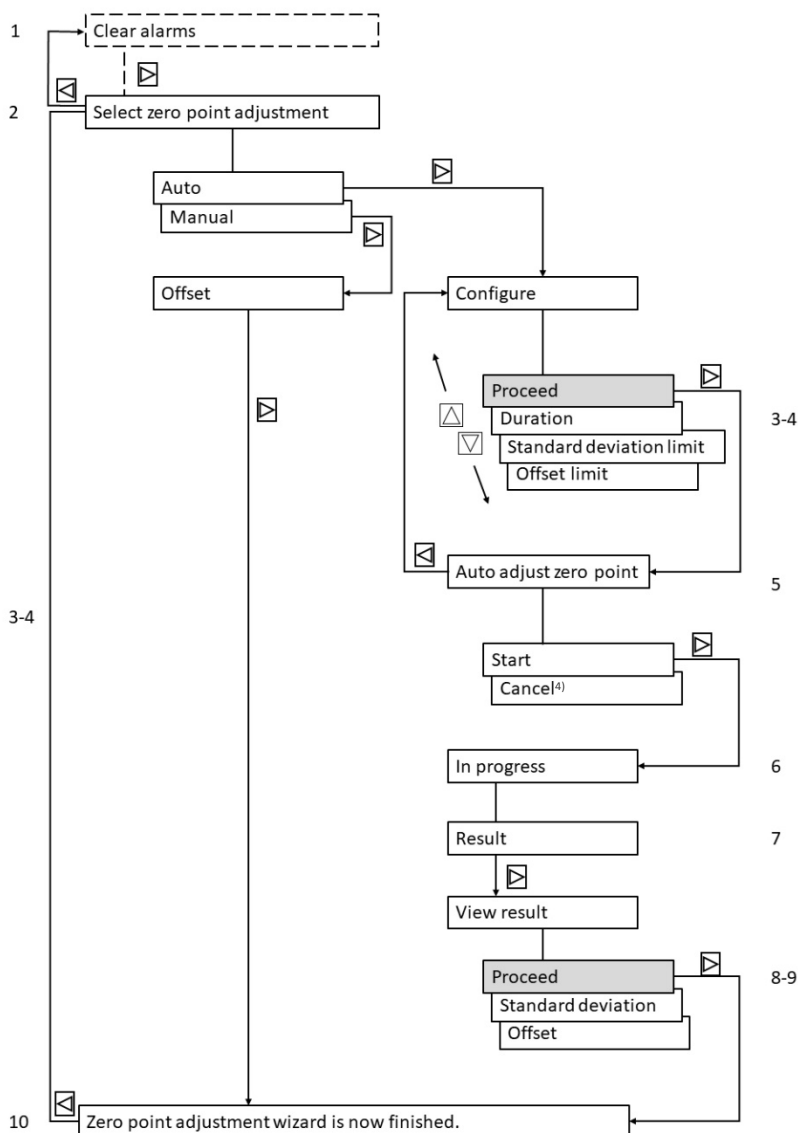

⁴⁾ Pressing Cancel will bypass the Zero Point Adjustment and go to view 10.



View no.	Text	Options/description
1	Clear alarms	"Clear Alarms" and alarm list are only shown if alarms are present.
2	Select zero point adjustment type	Auto, Manual
3-4	Configure	Configure duration and limits
5	Auto adjust zero point	Cancel, Start (progress, result, standard deviation and offset)
6	In progress	The progress bar is shown
7	Result	Information on success or failure of zero point adjustment
8-9	View result	Offset values and standard deviation

NOTE:

View result

Standard Deviation and Offset values are only updated if the zero point adjustment was completed successfully. Otherwise the previous values are used.

Wizards

The HMI wizard graphics show an overview of each HMI wizard and of the keys used to navigate through the wizards. In the upper left corner of each view the wizard name (for example "Process Values") and the step name (for example "Unit") of the wizard is shown. In the upper right corner the view number (for example 5 of 18 in the Process Values wizard) is shown.

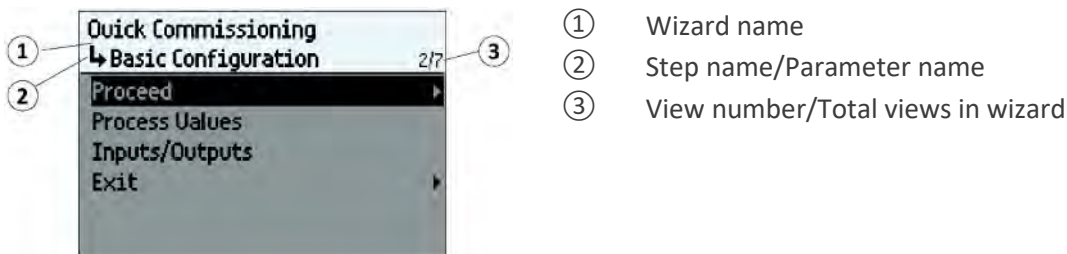

Fig. 48: HMI wizard graphics

The purpose of the HMI wizards is to guide you through a quick set-up of various parameters.

The following HMI wizards are available:

- Quick Commissioning
- Process Values
- Zero Point Adjustment
- Inputs/Outputs
- Gas Application
- Pulsating Flow
- Dosing Application

Use the and keys to highlight the desired HMI wizard and press right key to enter the wizard. The first view shows a short description of which settings can be done.



Key operation

Basic navigation in the HMI wizards is shown in the graphics.

To change settings, use the  and  keys to highlight wanted setting, then press  key to select. Confirm selection by pressing  key again.

When you reach the end of the wizard, e.g. "Process Values wizard is now finished", press  key to go back to wizard list.

6.3.2.5. Process Values Wizard (menu item 1.3)

The Process Values wizard will guide you through setup of process values for your application. The prioritizing of the process values automatically configures the measurement views on the display. The process value configured as 1st Process Value is set as first display view.

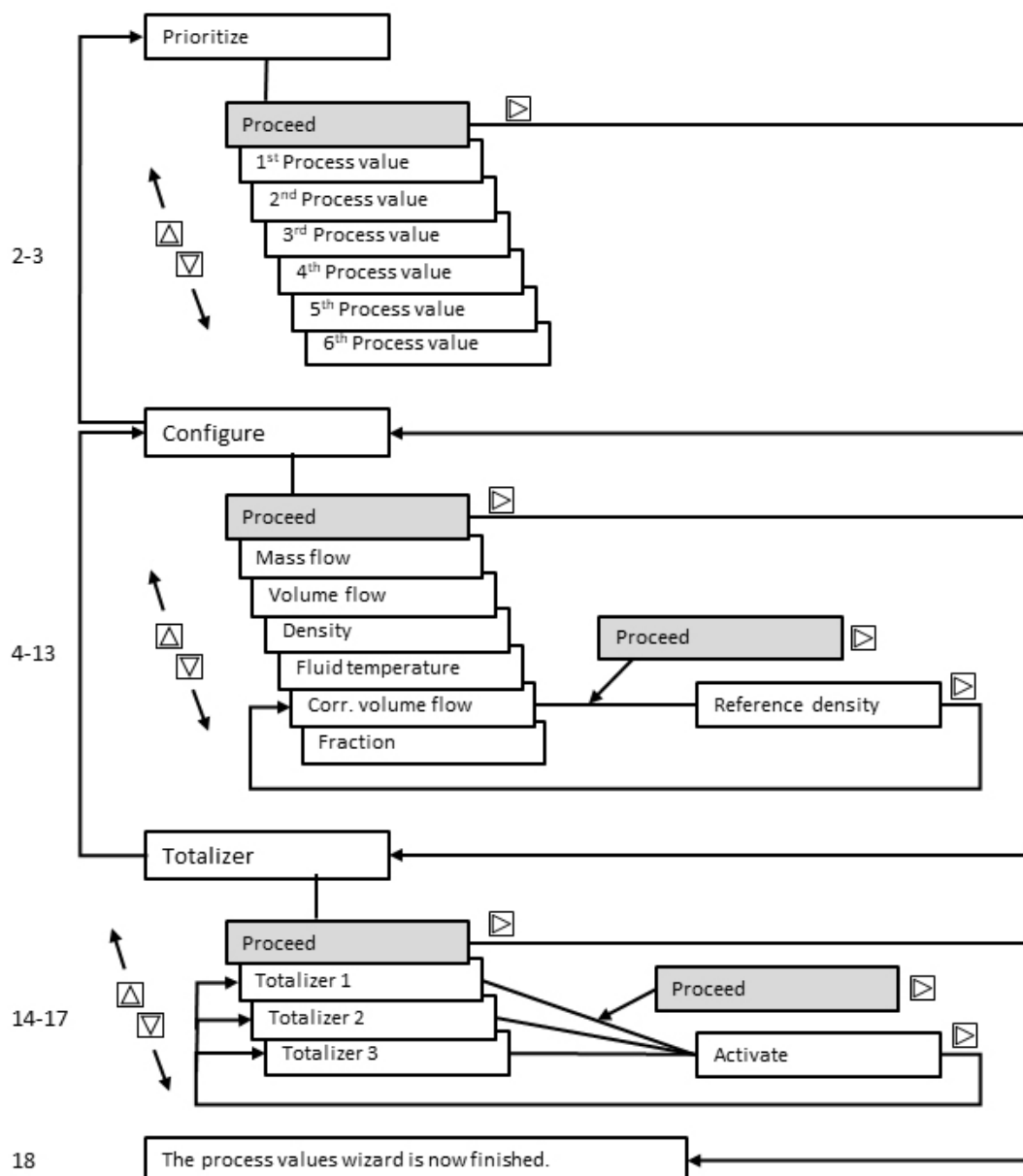



View no.	Text	Options/Description
2-3	Prioritize	Prioritize the process values
3-14	Configure	Configure the process values (unit, low flow cut-off, limits, and hysteresis)
14-17	Totalizer	Configure totalizers (if activated in operating view, it is possible to reset totalizer without password access)

6.3.2.6. Inputs/Outputs Wizard (menu item 1.4)

The Input/Output wizard will guide you through setup of inputs and outputs on channels 1 to 4. The channels 2 to 4 are optionally available.

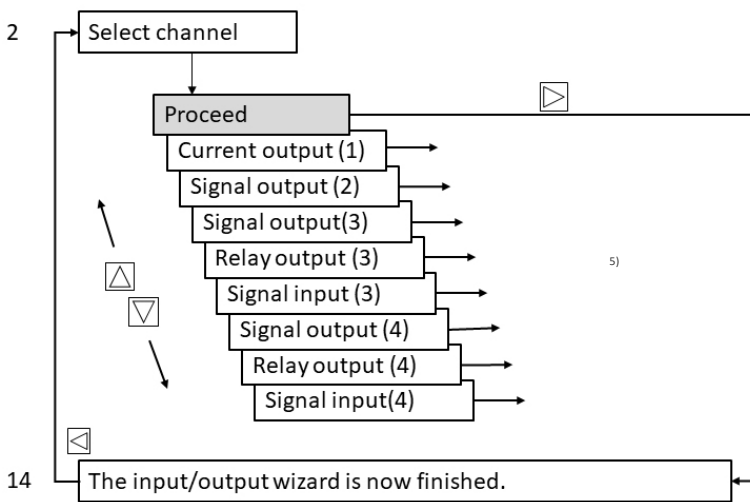

⁵⁾ See appropriate graphic for configuration of the input/output function.

View no.	Text	Options/Description
2	Select Channel	Select the channel to be configured
3-14	Configuration	Configure selected channel

Channels 3 and 4 can only be assigned to one function (signal output, relay output or signal input).

Current output - channel 1

The Current Output on Channel 1 is a 4 to 20 mA output with HART communication.

Communication modules - Channel 1

Modules with Modbus RTU RS485 and Profibus PA/DP communication are optionally available.

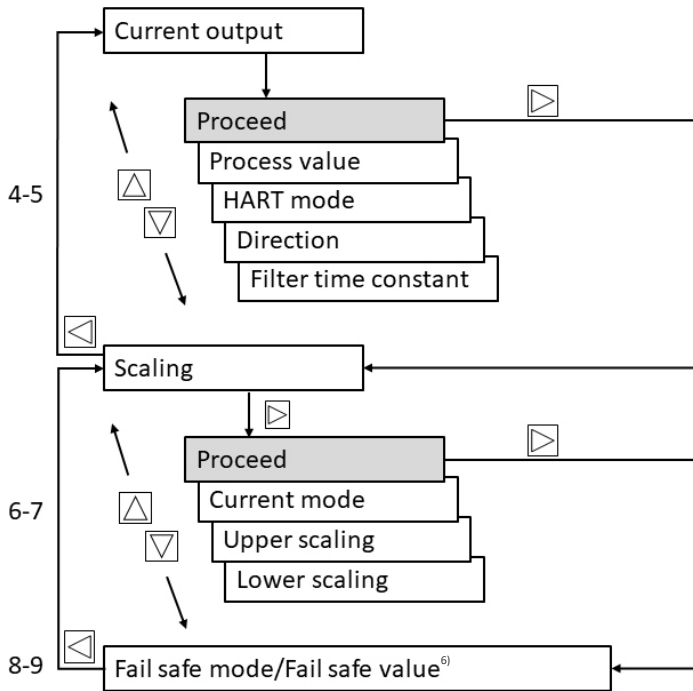

⁶⁾ When pressing  you will return to view "Select Channel".

View no.	Text	Options/Description
4-5	Current Output	Configure current output basic settings
6-7	Scaling	Configure current mode, upper and lower scaling
8-9	Fail Safe Mode/ Fail Safe Value	Select current output reaction in case of a fault

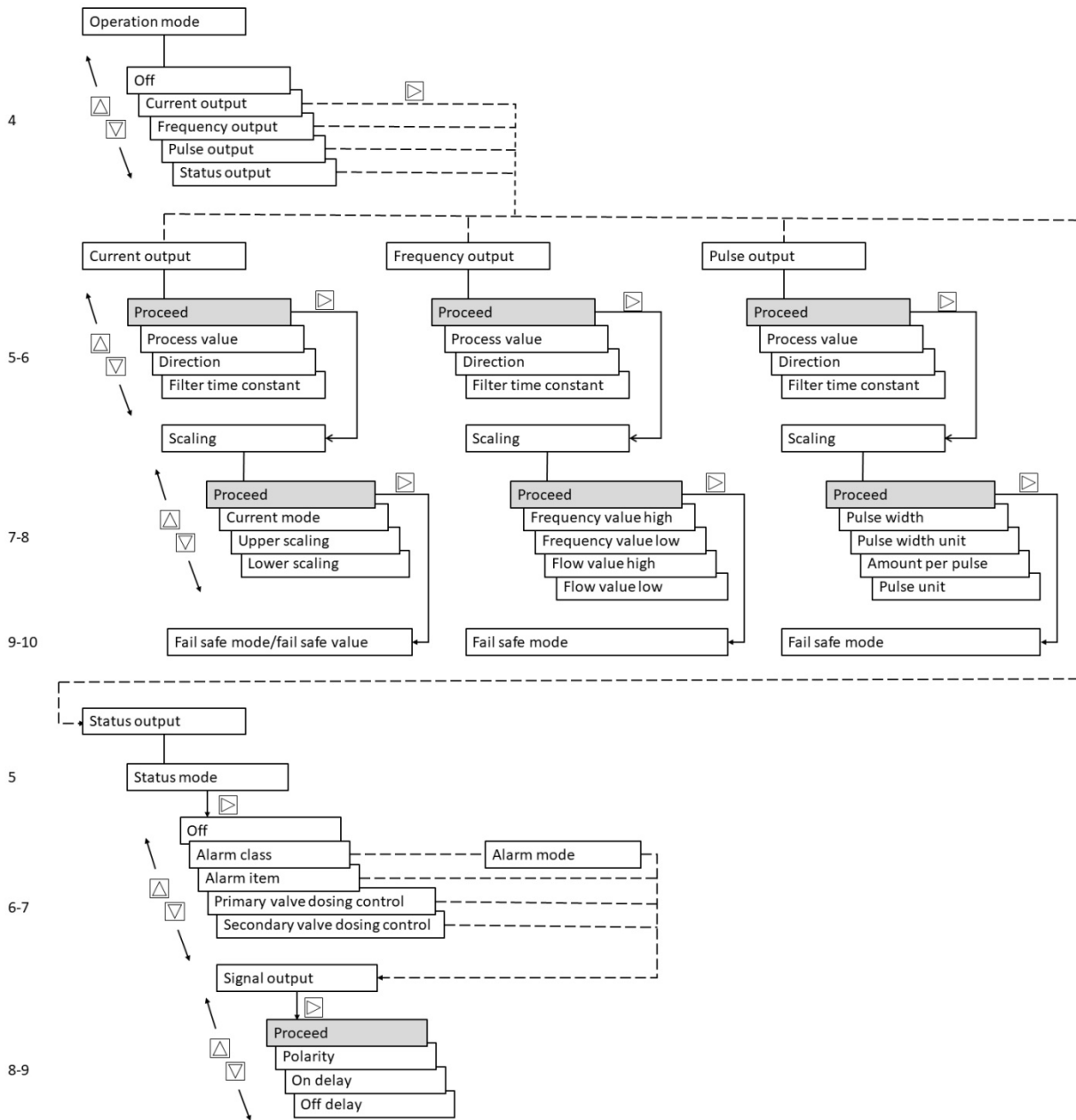

Current/Frequency/Pulse

View no.	Text	Options/description
4	Operation Mode	Select the output functionality
5-6	Output function	Configure the output basic settings
7-8	Scaling	Configure the output scaling
9-10	Fail Safe Mode / Fail Safe Value	Select the signal output reaction in case of a fault

Status

View no.	Text	Options/description
5	Status Mode	Select the digital output functionality
6-7	Configuration	Configure the alarm (only if Alarm Class or Individual alarms is selected)
8-9	Output polarity and delay	Set the output polarity and delay

Relay output - channels 3 to 4

The Relay Output can be configured to either discrete one or two-valve dosing control or alarm/status.

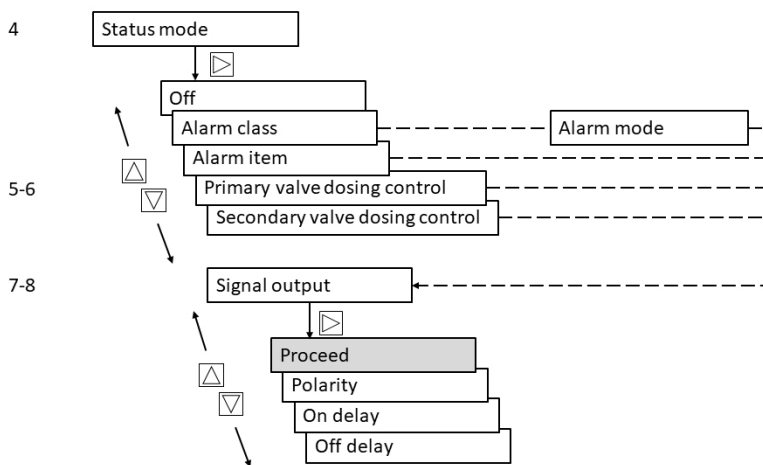

View no.	Text	Options/description
4	Status Mode	Select the status output functionality
5-6	Configuration	Configure the alarm (only if Alarm Class or Individual alarms is selected)
7-8	Output polarity and delay	Set the output polarity and delay

Signal input - channels 3 to 4

The Signal Input can be configured to either Dosing control, Totalizer reset, Remote zero adjust or Force/Freeze output(s).

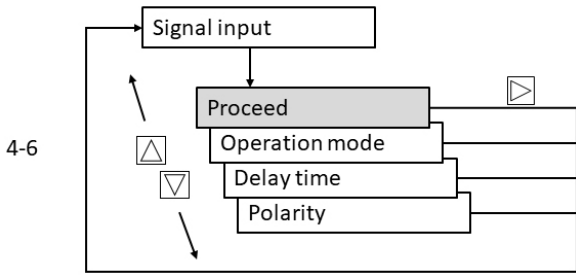

View no.	Text	Options/description
4	Operation Mode	Select the signal input functionality
5	Delay Time	Set the signal input delay time
6	Polarity	Set the signal input polarity

6.3.2.7. Gas Application Wizard (menu item 1.5)

The Gas Application wizard will guide you through configuration of essential parameters for measuring gas flow. As default Low Flow Cut-Off and Empty Tube Detection are disabled. Actual volume flow is difficult to use with low pressure; hence we recommend to use Corrected Volumeflow.

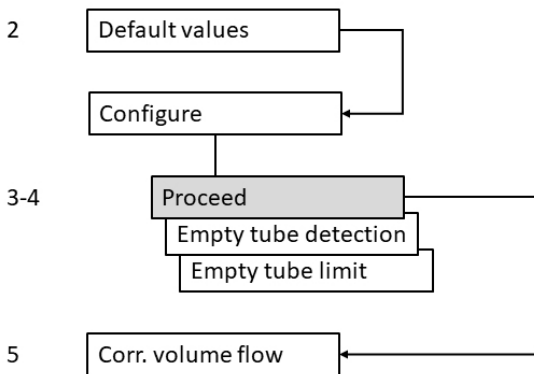

View no.	Text	Options/description
2	Default Values	Select whether or not to use the default values
3-4	Configure	Configure empty tube detection and limit
5	Corr. Volumeflow	Configure settings for corrected volumeflow



6.3.2.8. Pulsating Flow Wizard (menu item 1.6)

The Pulsating Flow wizard will guide you through configuration of essential parameters for applications with pulsating flow. As default the Totalizer will be set to Balanced, the Process Noise Damping is set to 4 and the Low Flow Cut-Off value will be raised.

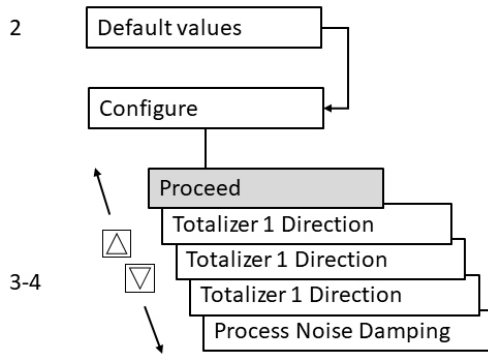

View no.	Text	Options/description
2	Default Values	Select whether or not to use the default values
3-4	Configure	Configure totalizer direction



6.3.2.9. Dosing Application Wizard (menu item 1.7)

The Dosing Application wizard will guide you through configuration of each recipe for dosing control including valve control (discrete/analog) and fault handling. The valve control is done using channels 2, 3 and 4.

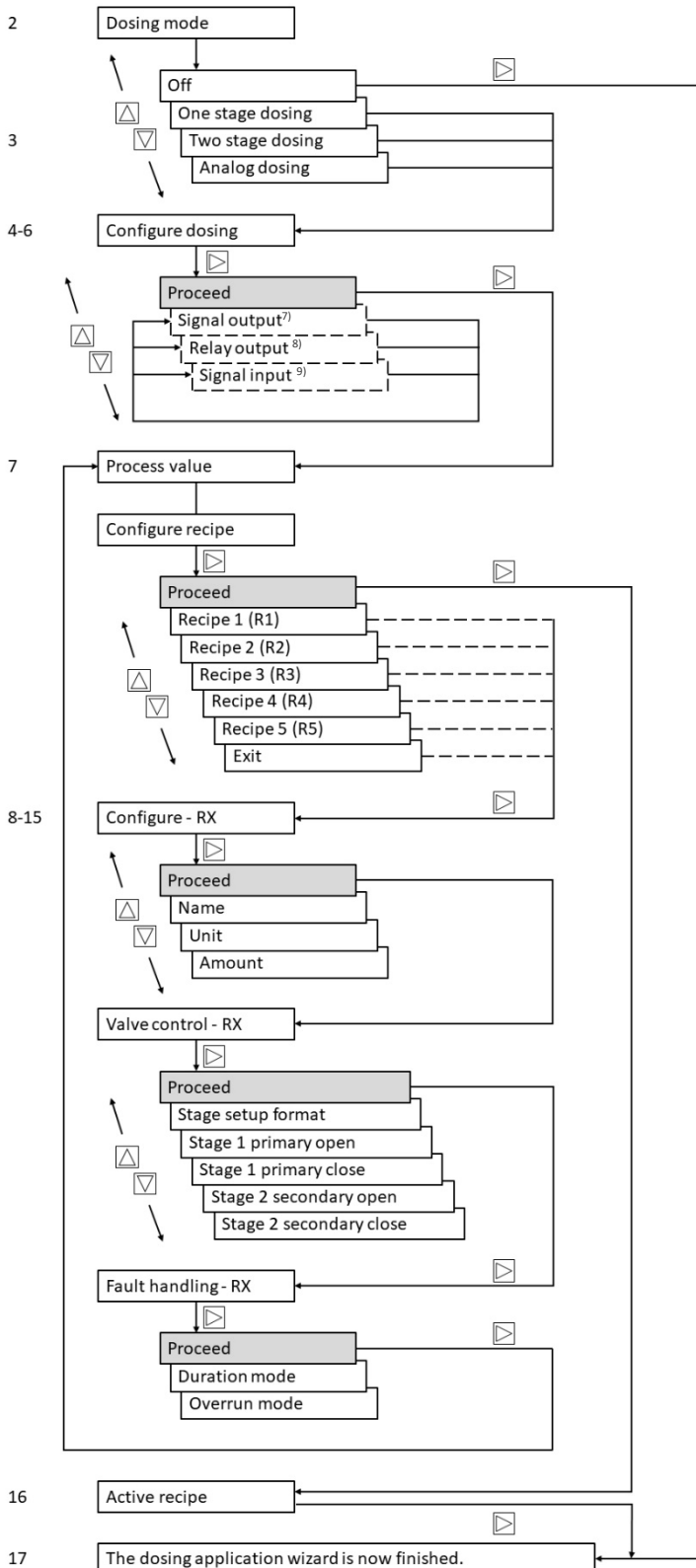

- ⁷⁾ Set Operation Mode to Status Mode and set Status Mode to control Primary Valve or Secondary Valve.
- ⁸⁾ Set Status Mode to Primary Valve or Secondary Valve.
- ⁹⁾ Set Operation Mode to Dosing Control.



View no.	Text	Options/description
2	Dosing Mode	Select the dosing mode to control the valve(s) on the output
3	Dosing options	Setup instructions for the selected dosing mode
4-6	Configure Output	Configure the output to control the valves
7	Process Value	Select the process value
8-15	Configure recipe	Configure the recipe (valve control and fault handling)
16	Active Recipe	Select a dosing recipe

For dosing setup, see “Dosing” (chapter 8.8, page 116).

6.3.3. Power-up

Power up the device. Devices with local display show a screen for initial startup.



7. Operating Display

A considerable amount of information regarding the operation and status of the flow meter is available to the user via the local display (HMI).

In this chapter you will find information on how to monitor and operate the device using the local display (HMI).

7.1. Operating Instructions

7.1.1. Local Display (HMI)

Operation via local user interface

The device is operated with the capacitive proximity keypad on the local user interface.

The elements are actuated by touching the glass panel above the appropriate key. The glass is 10 mm ($\frac{3}{8}$ "") thick. Pressing harder will not activate the key, but using a thumb instead of a finger tip will help. The text display above the operating elements gives a menu-guided operation of the individual device function/parameters. Successful operation of the key is confirmed by a small green LED at the right of the display.

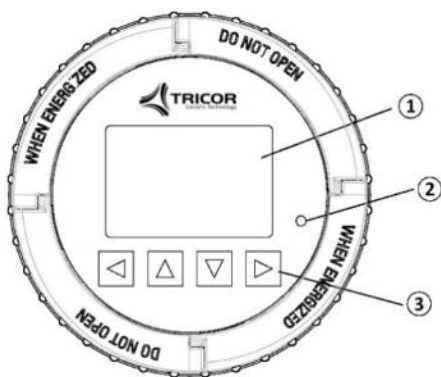

- ① Full graphical display
- ② LED (for indication of key operation)
- ③ Capacitive proximity keypad

Fig. 49: Local user interface

NOTE:

Recalibration of the keypad

When the lid is mounted, all keys are recalibrated (approximately 40 seconds). During recalibration the LED is on and the keys cannot be operated.

If one of the keys is pressed for more than 10 seconds, this key is recalibrated (duration less than 10 seconds). Release the key for further operation.

NOTE:

HMI timeout

If no key is pressed for 10 minutes, the display switches to show operation view.



NOTE:

Operation does not require opening of the device. This means that the high degree of protection of IP67 and safety in hazardous areas are guaranteed at all times.

NOTE:**Display backlight**

The display backlight goes off automatically 30 seconds after the last keypress.

7.1.1.1. Display View Structure

There are three view types:

- **Operation view**
The operator view shows up to six operation views (chapter 7.1.1.3, page 85). The operation views are fully configurable to show different process values in different operation view types. Depending on the operation view type configuration the view is either measurement view or alarm view.
 - **Measurement view:** Displays the measurement values, see “Operation View” (chapter 7.1.1.3, page 85).
 - **Alarm view:** Displays the active alarms in a list, see “Operation View” (chapter 7.1.1.3, page 85).
 - **Operating view:** Enables the totalizer reset and the dosing control, see “Operation View” (chapter 7.1.1.3, page 85).
 - **Diagnostic view:** Displays six configurable measurement/diagnostic values, see “Operation View” (chapter 7.1.1.3, page 85).
- **Navigation view**
The “Navigation view” (chapter 7.1.1.8, page 92) shows the menus and parameters. The navigation view is used to navigate through the menus and parameters in the device.
- **Parameter view**
The “Parameter View” (chapter 7.1.1.9, page 94) can be entered from the navigation view. The parameter view is used to view and edit the parameters.

Navigating the operation view

Browse the operation views and menu items using the control buttons as follows:

Key	Function
	No functionality
	Go to the previous menu in the operation view
	Go to the next menu in the operation view
	Enter the navigation view

Tab. 11: Measurement view



Key	Function
	No functionality
	Go to the previous menu in the operation view
	Go to the next menu in the operation view
	Enter alarm view level 2

Tab. 12: Alarm view level 1

Key	Function
	Enter alarm view level 1
	Select the item above in the list; keep pressing the key to accelerate scrolling up the selection list
	Select the item below in the list; keep pressing the key to accelerate scrolling down the selection list
	Enter alarm view level 3

Tab. 13: Alarm view level 2

Key	Function
	Enter alarm view level 2
	No functionality
	No functionality
	No functionality

Tab. 14: Alarm view level 3

Key	Function
	No functionality
	Previous view
	Next view
	Enter operating view level 2

Tab. 15: Operating view level 1

Key	Function
	Enter operating view level 1
	Select action to perform
	Select action to perform
	Perform selected action

Tab. 16: Operating view level 2

Key	Function
⏏	No functionality
⏪	Go to the previous menu in the operation view
⏩	Go to the next menu in the operation view
⏴	Enter the navigation view

Tab. 17: Diagnostic view

The following graphic shows an example of how to navigate between measurement views and alarm views with measurement views 1, 3, and 4 as well as alarm view 5 enabled.

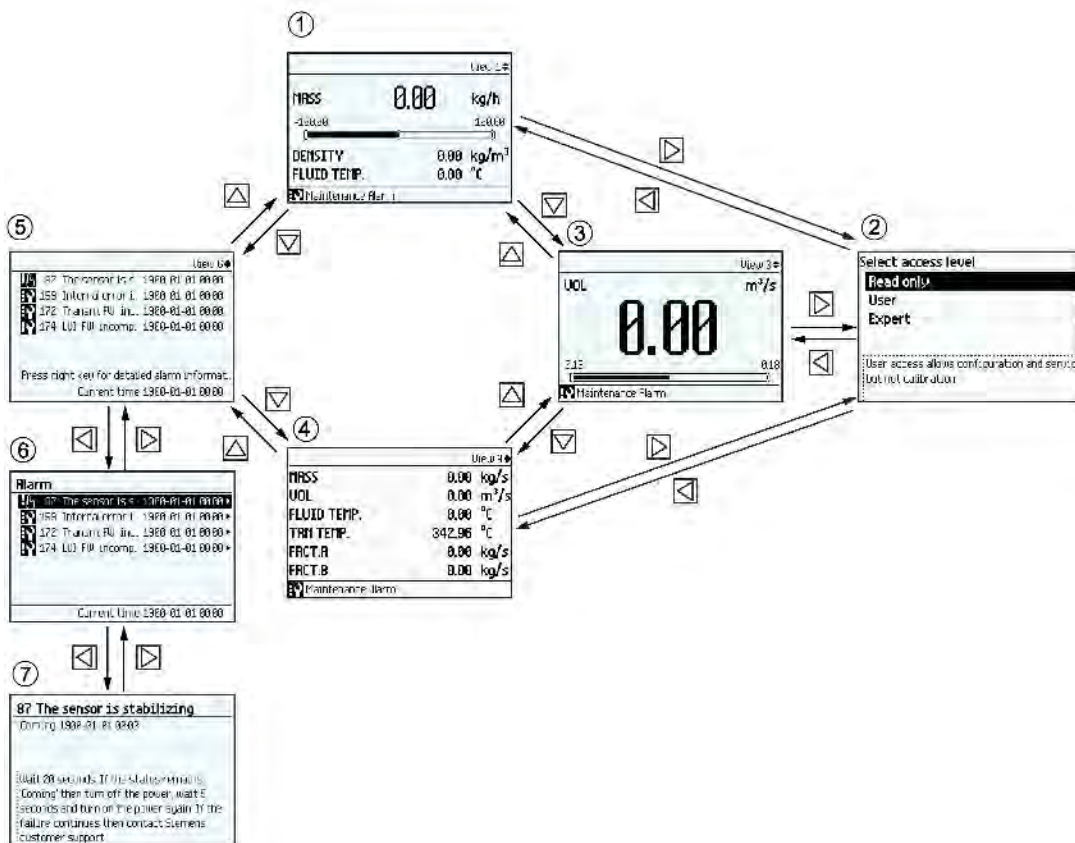

Fig. 50: How to navigate between measurement views and alarm views

- ① Measurement view
- ② Access level view
- ③ Measurement view
- ④ Measurement view
- ⑤ Alarm view - level 1
- ⑥ Alarm view - level 2
- ⑦ Alarm view - level 3



Navigating the navigation view

Browse the navigation view and menu items using the control buttons as follows:

Key	Function
	Enter the next higher level of the navigation view (for example from level 2 to level 1). If located on level 1 in the navigation view then enter the operation view.
	Select the item above in the list; keep pressing the key to accelerate scrolling up the selection list. If the key is pressed when the top item is selected, the bottom item will be highlighted.
	Select the item below in the list; keep pressing the key to accelerate scrolling down the selection list. If the key is pressed when the bottom item is selected, the top item will be highlighted.
	Enter the next lower level of the navigation view (for example from level 1 to level 2). If a parameter is selected in the navigation view then enter the parameter view.

Tab. 18: Navigation view

Editing the parameters

When this symbol is shown in the graphics, the four buttons on the HMI are used for changing the parameters as described below.

Key	Function
	Select the next left position. If the most left position is selected, exit the parameter edit view without confirming the changes. Keep pressing the key to jump to the most left position.
	Change the selected number/character. Numeric characters: increase the number by one (for example from 7 to 8) ASCII characters: select the previous character in the alphabet.
	Change the selected number/character. Numeric characters: decrease the number by one (for example. from 8 to 7) ASCII characters: select the next character in the alphabet.
	Select the next right position. If most right position is selected, confirm the change and exit the parameter edit view. Keep pressing the key to jump to the most right position.

Tab. 19: Parameter edit view

Key	Function
	Exit parameter edit view
	No functionality
	No functionality
	No functionality

Tab. 20: Parameter read only view

7.1.1.2. Access Control

The user can view all parameters in the HMI menu but the parameters are protected against changes with access level control. The user gains access when entering the navigation view by selecting one of the following access levels.

- **Read only**
Allows no configuration. The user is only able to view the parameter values. No PIN code required.
- **User**
Allows configuration and service of all parameters except calibration parameters. Default PIN code is 2207 (2457 for meters shipped before 01.11.2018).
- **Expert**
Allows configuration and service of all parameters including flow and density calibration parameters. Default PIN code is 2208 (2834 for meters shipped before 01.11.2018).

PIN codes can be changed in menu 5 "Security".

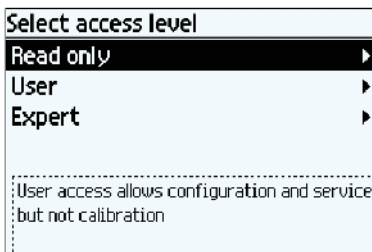

Fig. 51: HMI menu: Select access level

NOTE:

Lost PIN code

If the PIN code is lost, provide KEM/AW-customer support with the transmitter serial number (see nameplate). TRICOR customer support will provide a code to be entered in Reset PINs (menu item 5.1.3).

Disable access level control

If logged in as "Expert" you can "Disable Access Level Control" meaning that you will always be logged in as "User" and will not be prompted to enter the password. Enabling the access level control requires entering the "Expert" password.

Auto Log Off function

With the "Auto Log Off" function enabled (default), you will be prompted to enter the password if no keys have been pressed for ten minutes before operating the display again. With the "Auto Log Off" function disabled, you will not be prompted to enter the password before operating the HMI.



NOTE:

Device restart

Whenever the device is restarted, the access level is reset to Read Only.



7.1.1.3. Operation View

The operation view can be displayed in up to six user-configured views. Switch manually between the enabled views with the keys  and . The actual operator view number (1 to 6) is shown in the upper right corner of the figures below.

The view types including the number of process values shown in the operation view are configured in HMI menu structure.

In view 1 only measurement or diagnostic views can be selected. In views 2 to 6 all view types can be selected.

Navigation view can only be accessed by pressing the right key in a measurement or a diagnostic view.

- Measurement views
 - Single value
 - Three values
 - One value and bargraph
 - One value and graph
 - Six values
- Operating views
 - Totalizer
 - Dosing
- Alarm view
 - Alarm List
- Diagnostic view
 - Six Diagnostic Values

In general, all of the HMI views show the following:

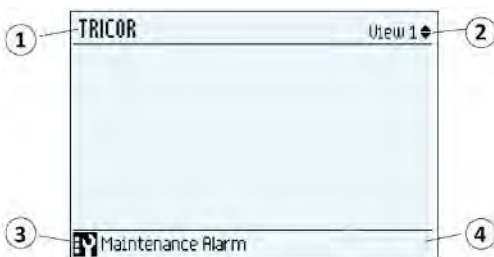

Fig. 52: Example HMI view

- | | | |
|---|-------------------|--|
| ① | Long TAG | Describes the measurement point and is shown in all operation views. Can be changed via the menu "Long TAG". |
| ② | View number | Shows the operation view number.
The number refers to the view number configured in the menu "Setup" → "Display". |
| ③ | Alarm icon | Indicates an active alarm.
Shows the alarm class, see "Device Status Symbols" (chapter 10.1, page 134). Only shown if an alarm is active. |
| ④ | Alarm status text | Describes the alarm. Only shown if an alarm is active. |

7.1.1.4. Measurement Views

Single value

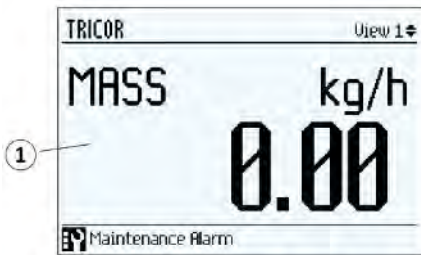

Fig. 53: Measurement view – Single value

- ① Process value

The user-defined process value to be displayed is configured in menu "View" (1-6) located at "Setup" → "Display"

Three values

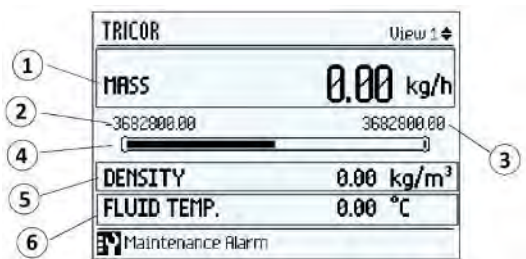

Fig. 54: Measurement view – Three values

- ① First process value

The user-defined process value to be displayed is configured in menu "View" (1-6) located at "Setup" → "Display"

- ② Lower Limit Alarm

The lower limit of the bar graph is defined by the lower alarm limit of the selected process value.

- ③ Upper Limit Alarm

The upper limit of the bar graph is defined by the upper alarm limit of the selected process value.

- ④ Bargraph

Shows the first process value in relation to its configured maximum and minimum limits (Upper Alarm Limit and Lower Alarm Limit for the selected process value).

- ⑤ Second process value

The user-defined process value to be displayed is configured in menu "View" (1-6) located at "Setup" → "Display"

- ⑥ Third process value

The user-defined process value to be displayed is configured in menu "View" (1-6) located at "Setup" → "Display"

NOTE:

Bargraph

The bargraph limits are defined as the lower and upper alarm values.



One value and bargraph

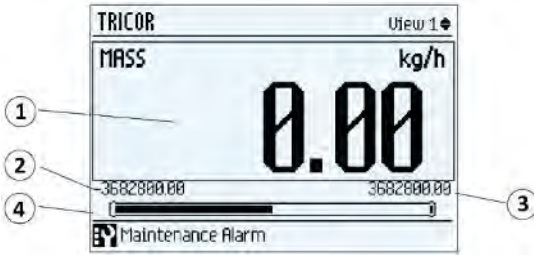

Fig. 55: Measurement view – One value and bargraph

- | | | |
|---|-------------------|--|
| ① | Process value | The user-defined process value to be displayed is configured in menu "View" (1-6) located at "Setup" → "Display" |
| ② | Lower Limit Alarm | The lower limit of the bar graph is defined by the lower alarm limit of the selected process value. |
| ③ | Upper Limit Alarm | The upper limit of the bar graph is defined by the upper alarm limit of the selected process value. |
| ④ | Bargraph | Shows "1st Process value" in relation to its configured maximum and minimum limits (Upper Alarm Limit and Lower Alarm Limit for the selected process value). |

NOTE:

Bargraph

The bargraph limits are defined as the lower and upper alarm values.

One value and graph

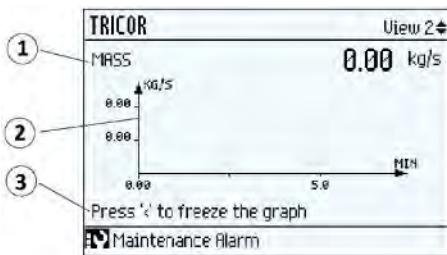

Fig. 56: Measurement view – One value and graph

- | | | |
|---|---------------|-----------------------------------|
| ① | Process Value | |
| ② | Graph | |
| ③ | Instruction | Press to freeze/unfreeze display |

Six values

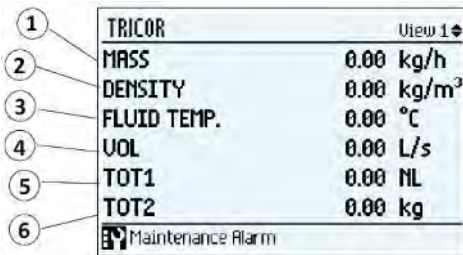

Fig. 57: Measurement view – Six values

- | | | |
|---|----------------------|--|
| ① | First process value | The user-defined process value to be displayed is configured in menu "View" (1-6) located at "Setup" → "Display" |
| ② | Second process value | The user-defined process value to be displayed is configured in menu "View" (1-6) located at "Setup" → "Display" |
| ③ | Third process value | The user-defined process value to be displayed is configured in menu "View" (1-6) located at "Setup" → "Display" |
| ④ | Fourth process value | The user-defined process value to be displayed is configured in menu "View" (1-6) located at "Setup" → "Display" |
| ⑤ | Fifth process value | The user-defined process value to be displayed is configured in menu "View" (1-6) located at "Setup" → "Display" |
| ⑥ | Sixth process value | The user-defined process value to be displayed is configured in menu "View" (1-6) located at "Setup" → "Display" |

7.1.1.5. Operating Views

Totalizer (level 1)

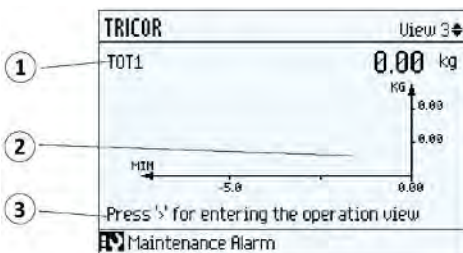

Fig. 58: Operating view – Totalizer (level 1)

- | | | |
|---|---------------|--|
| ① | Process value | |
| ② | Graph | |
| ③ | Instruction | Press \square to enter the operation view. |



Totalizer (level 2)

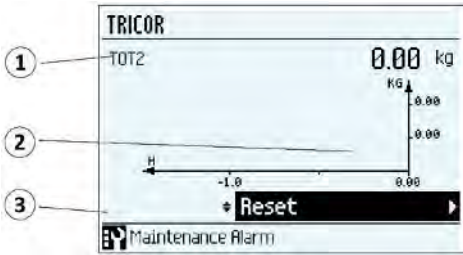

Fig. 59: Operating view – Totalizer (level 2)

- ① Process value
- ② Graph
- ③ Control

Dosing (level 1)

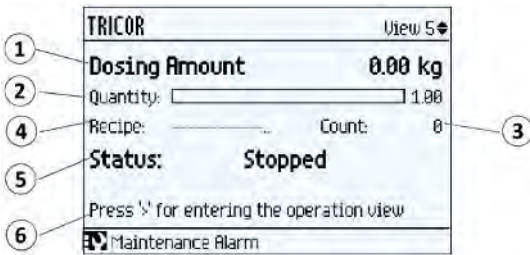



Fig. 60: Operating view – Dosing (level 1)

- | | | |
|---|--------------|--|
| ① | Dosed amount | Actual dosed amount |
| ② | Quantity | Set dosing amount |
| ③ | Count | Number of dosings |
| ④ | Recipe | Name of the selected recipe |
| ⑤ | Status | Dosing status |
| ⑥ | Instruction | Press  to enter the operation view. |

Dosing (level 2)

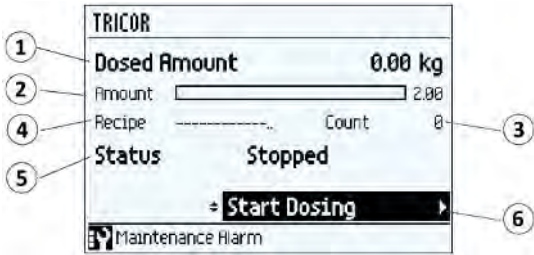

Fig. 61: Operating view – Dosing (level 2)

- | | | |
|---|--------------|-------------------------------------|
| ① | Dosed amount | Actual dosed amount |
| ② | Quantity | Set dosing amount |
| ③ | Count | Number of dosings |
| ④ | Recipe | Name of the selected recipe |
| ⑤ | Status | Dosing status |
| ⑥ | Instruction | Press to enter the operation view. |

7.1.1.6. Alarm Views

Alarm list (level 1)

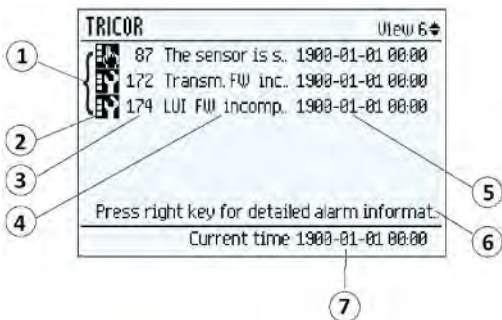

Fig. 62: Alarm view – Alarm list (level 1)

- | | | |
|---|-----------------------------|--|
| ① | List of alarms | List of all active alarms in device. |
| ② | Alarm icon | Shows the alarm class, see “Device Status Symbols” (chapter 10.1, page 134). |
| ③ | Alarm identification number | Shows the alarm identification number, see “Device Status Symbols” (chapter 10.1, page 134). |
| ④ | Alarm text | Short alarm name.
The complete alarm text can be viewed in the detailed alarm information view. |
| ⑤ | Alarm time stamp | Timestamp with the actual date and time when the alarm occurred. |
| ⑥ | Instruction | Press right key for detailed alarm information. |

In the alarm list (level 1) the active alarms are listed. Press to access the alarm list (level 2).



Alarm list (level 2)

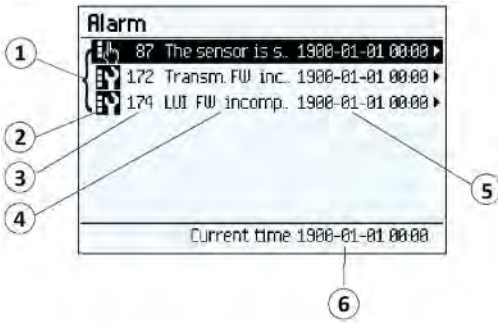

Fig. 63: Alarm view – Alarm list (level 2)

- | | | |
|---|-----------------------------|--|
| ① | List of alarms | List of all active alarms in device. Each Alarm can be selected for detailed information. |
| ② | Alarm icon | Shows the alarm class, see “Device Status Symbols” (chapter 10.1, page 134). |
| ③ | Alarm identification number | Shows the alarm identification number, see “Device Status Symbols” (chapter 10.1, page 134). |
| ④ | Alarm text | Short alarm name.
The complete alarm text can be viewed in the detailed alarm information view. |
| ⑤ | Alarm time stamp | Timestamp with the actual date and time when the alarm occurred. |
| ⑥ | Current time | Shows the current date and time. |

In the alarm list (level 2) it is possible to select any of the active alarms. Press or to scroll through the alarm list. Press to access detailed information of the highlighted alarm (level 3).

Alarm list (level 3)

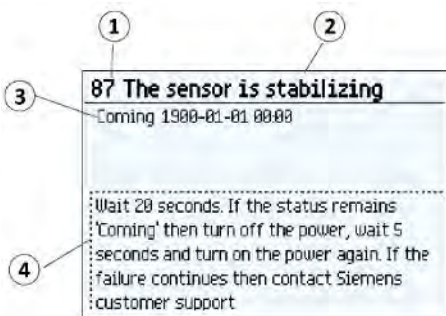

Fig. 64: Alarm view – Alarm list (level 3)

- | | | |
|---|------------|----------------------------------|
| ① | ID | Alarm identification number. |
| ② | Diagnostic | Describes possible causes. |
| ③ | Coming | Time stamp for alarm occurrence. |
| ④ | Action | Describes corrective action. |

In the detailed alarm information view (level 3) the diagnostic and action texts are displayed. Press to exit the detailed information view.

Alarm acknowledgement

There are two ways to have the alarms removed from the alarm list.

- Manual: The alarm remains in the alarm list until the alarm is manually acknowledged (ack.). The time of the acknowledgement is shown in the history log.
- Auto: The alarm is removed from the alarm list when the cause is removed (going)

7.1.1.7. Diagnostic view

Six diagnostic values

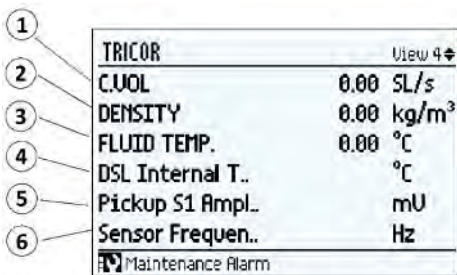

①	TRICOR	View 4
②	C.VOL	0.00 SL/s
③	DENSITY	0.00 kg/m ³
④	FLUID TEMP.	0.00 °C
⑤	DSL Internal T..	°C
⑥	Pickup S1 Ampl..	mU
	Sensor Frequen..	Hz
	Maintenance Alarm	

Fig. 65: Diagnostic view – Six diagnostic values

- | | | |
|---|---------------------------------|--|
| ① | First process/diagnostic value | The user-defined process value to be displayed is configured in menu "View" (1-6) located at "Setup" → "Display" |
| ② | Second process/diagnostic value | The user-defined process value to be displayed is configured in menu "View" (1-6) located at "Setup" → "Display" |
| ③ | Third process/diagnostic value | The user-defined process value to be displayed is configured in menu "View" (1-6) located at "Setup" → "Display" |
| ④ | Fourth process/diagnostic value | The user-defined process value to be displayed is configured in menu "View" (1-6) located at "Setup" → "Display" |
| ⑤ | Fifth process/diagnostic value | The user-defined process value to be displayed is configured in menu "View" (1-6) located at "Setup" → "Display" |
| ⑥ | Sixth process/diagnostic value | The user-defined process value to be displayed is configured in menu "View" (1-6) located at "Setup" → "Display" |

7.1.1.8. Navigation view

The navigation views present the menu structure of the device. All menu items are uniquely identified with menu item number.

Level 1 of the navigation view (entered from the operation view) covers the following groups:



1. Quick Start: Lists the most important parameters for quick configuration of the device. All parameters in this view can be found elsewhere in the menu.
2. Setup: Contains all parameters which are needed to configure the device.
3. Maintenance & Diagnostics: Contains parameters which affect the product behavior regarding maintenance, diagnostics and service.
Examples: Verification, failure prediction, device health, data logging, alarm logging, report, condition, monitoring, tests, etc.
4. Communication: Contains parameters which describe the Profibus, HART, Modbus communication settings of the device.
5. Security: Contains parameters which describe all security settings of the device.
6. Language: Parameter for changing the language of the HMI. Regardless of the language setting, the term for this parameter is always the English term (Language).

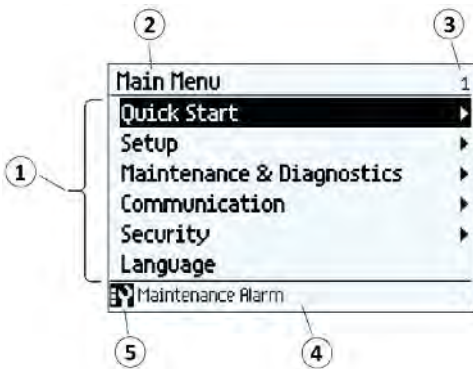

Fig. 66: Example of display in navigation view

- ① List of menus and parameters
- ② Name of the previously selected menu
- ③ Menu item number of highlighted menu
- ④ Alarm status text
- ⑤ Alarm icon

Menu item

In navigation view menus are identified by an arrow in the most right position.

When a menu is selected, the background turns black.



Fig. 67: Menu in navigation view ("Quick start" selected "Setup" not selected)

For further information on how to gain access to the menus, see "Access Control" (chapter 7.1.1.2, page 84).

Parameter item

In navigation view parameters are shown without an arrow in the most right position except when the parameter is selected. When selected, the parameter is expanded into two lines; the second line shows the value of the parameter, a lock icon (🔒) (only for read access level of the parameter), and an arrow in most right position.

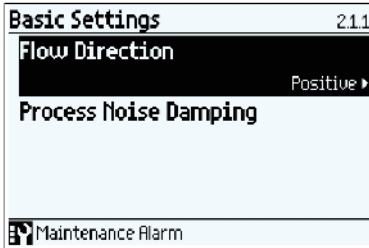

Fig. 68: Navigation view ReadWrite

The selected parameter can be edited in the parameter view.



Fig. 69: Navigation view ReadOnly

The selected parameter can only be viewed in the parameter view

7.1.1.9. Parameter View

Depending upon the access level, you can edit the value of the selected parameter or read the current value.

Numeric parameters edit view

Numeric parameters in edit view are displayed as shown here.

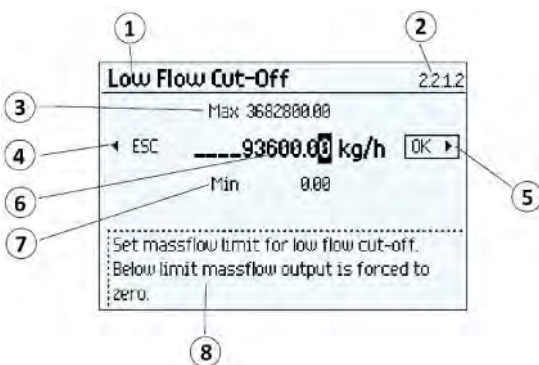

Fig. 70: Numeric parameter edit view









- ① Parameter name
- ② Parameter item number
- ③ Maximum value
- ④ Escape without saving (frame around ESC is only shown when cursor is in left-most position)
- ⑤ Confirm and save (frame around OK is only shown when cursor is in right-most position)
- ⑥ Value to be edited
- ⑦ Minimum value
- ⑧ Help text describing the parameter function. The help text appears if no key is pressed for three seconds.

NOTE:**##### signs in display**

The display is unable to show the measured value. Change the measurement unit or the resolution.





Changing a value:

1. Select the digit to be changed by pressing  and  keys.
2. Use  key to increase the value and  key and decrease the values.
3. Press  key in the rightmost position to confirm the changes, or press  key in the leftmost position to escape the view without changing the value.

NOTE:

Ensure that the new value is within the minimum/maximum range.

Changing the resolution:

4. Select decimal point by pressing  and  keys.
5. Move decimal point by pressing  key (moves decimal point to the left) or  key (moves decimal point to the right).

In order to change the resolution of the process value shown in the operation view (for example massflow), change the resolution of one configuration parameter for this process value (for example "Low Flow Cut-off" (menu item 2.2.1.2)). Any changes in resolution will change the resolution of all configuration parameters for this process value as well.

The resolution can also be changed by setting the decimal places parameter for the selected process value, for example the decimal places for process value Massflow is defined in parameter menu item 2.2.1.8.

Numeric parameter read only view

Numeric parameters in read only view are displayed as shown here.

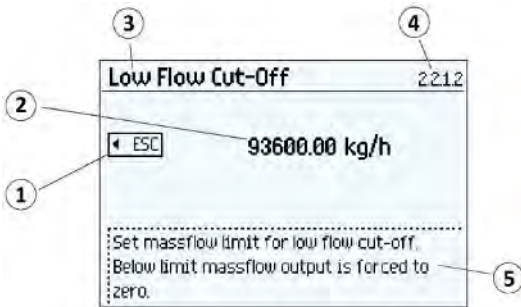

Fig. 71: Numeric parameter read only view

- ① Escape
- ② The set value
- ③ Parameter name
- ④ Parameter item number
- ⑤ Help text describing the parameter function.

The read only view is shown if you don't have access to edit parameters. The view shows the set value. Press **ESC** to escape the view.

Parameter list edit view

Lists of parameters in edit view are displayed as shown here.

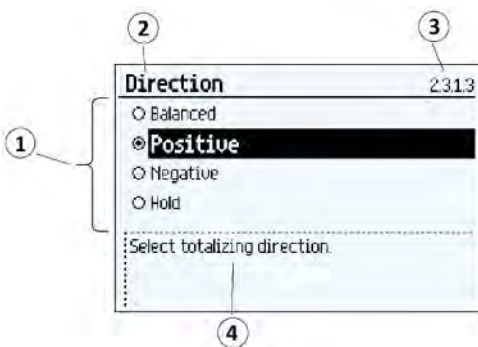

Fig. 72: List Selection edit view

- ① Parameter list
- ② Parameter name
- ③ Parameter item number
- ④ Help text describing the parameter function. The help text appears if no key is pressed for three seconds.

Select the value by using **▲** and **▼** keys, and press **▶** to confirm changes. Press **ESC** to escape the view without changing the value.



Parameter list read only view

Lists of parameters in read only view are displayed as shown here.

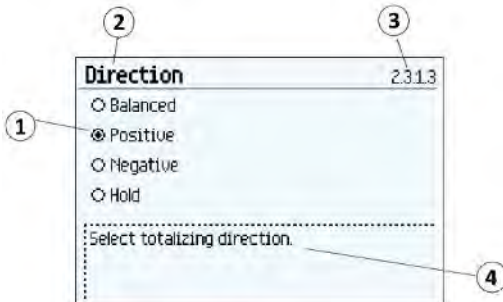



Fig. 73: List selection read only view

- ① Parameter value selected
- ② Parameter name
- ③ Parameter item number
- ④ Help text describing the parameter function. The help text appears if no key is pressed for three seconds.

The read only view is shown if you do not have access to edit parameters. Press  to escape the view.

Multiselection view

It is possible to select/deselect multiple alarms to be suppressed.

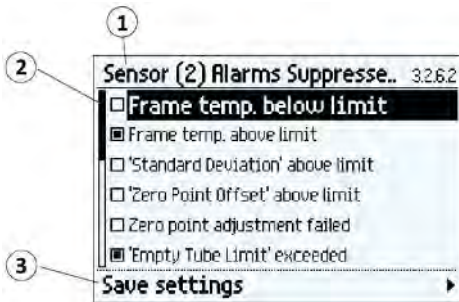

Fig. 74: Multiselection view

- ① Parameter name
- ② Alarm list
- ③ Save settings (select and press right key to save settings)

Use  and  to scroll through the alarms. Use  to select/deselect the alarm.

The marked alarms will NOT be suppressed.

NOTE:

Save settings

To activate the selections, press  to save settings before leaving the view.



Fixed display texts

The following table lists the fixed display texts for the process value names available on the operation view.

Fixed display text	Process value name
MASS FLOW	Mass flow
VOL.FLOW	Volume flow
S.VOL FLOW	Standard Volume flow
R.DENSITY	Reference Density
DENSITY	Density
MEDIUM TEMP.	Medium Temperature
FRACTION A	Fraction A
FRACTION B	Fraction B
FRCT.A %	Fraction A %
FRCT.B %	Fraction B %
TOT1	Totalizer 1
TOT2	Totalizer 2
TOT3	Totalizer 3

Tab. 21: Process values

Fixed display text	Diagnostic value name
DRIV.CURR.	Driver current
FRAME TEMP.	Frame temperature
MASS RAW	Raw mass flow
PICKUP S1	Pickup S1
PICKUP S2	Pickup S2
SENSOR FREQ.	Sensor frequency
TRANSM. TEMP.	Transmitter temperature
VOL RAW	Raw volume flow
CURRENT (CH1)	Current (channel 1)
CURRENT (CH2)	Current (channel 2)
CURRENT (CH3)	Current (channel 3)
CURRENT (CH4)	Current (channel 4)
FREQ. (CH2)	Frequency (channel 2)
FREQ. (CH3)	Frequency (channel 3)
FREQ. (CH4)	Frequency (channel 4)
PULSE (CH2)	Pulse (channel 2)
PULSE (CH3)	Pulse (channel 3)
PULSE (CH4)	Pulse (channel 4)
STATUS (CH2)	Status (channel 2)
STATUS (CH3)	Status (channel 3)
STATUS (CH4)	Status (channel 4)
INPUT (CH3)	Input (channel 3)
INPUT (CH4)	Input (channel 4)

Tab. 22: Diagnostic values



8. Functions

8.1. Process Values

The process values are updated every 10 ms (100 Hz update rate) synchronous with the DSP update cycle.

8.1.1. Process Value Parameters

The process values are:

- Mass flow
- Volume flow
- Standard volume flow
- Density
- Process media temperature
- Fraction A (mass flow or volume flow)
- Fraction B (mass flow or volume flow)
- Fraction A %
- Fraction B %

All process values are available to be located to the current output, Modbus RS485 and Profibus on Channel 1. For Channel 2 to 4 all process variables are available

8.1.2. Limits and Hysteresis

8.1.2.1. Limits

Limit alarms and warnings can be assigned to all process values. The following limit parameters are available for each process value:

- Upper Limit Alarm
- Upper Limit Warning
- Lower Limit Warning
- Lower Limit Alarm
- Alarm Hysteresis

The system reports a process alarm when the process value exceeds the Upper Limit Alarm or the Lower Limit Alarm. Likewise, the system reports a process warning when the process value exceeds the Upper Limit Warning or the Lower Limit Warning. Process value alarms and warnings are displayed in the HMI as well as at the communication interfaces.



8.1.2.2. Hysteresis

The hysteresis functions as follows:

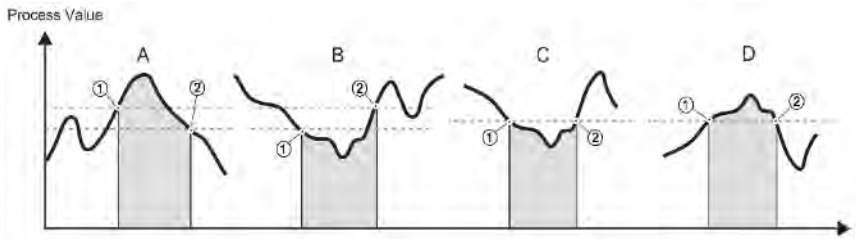

Fig. 75: Hysteresis

A: Upper alarm limit with hysteresis

The alarm is triggered when the process value overshoots the Upper Alarm Limit (1). The alarm is cleared when the process value undershoots the Upper Alarm Limit minus hysteresis (2).

B: Lower alarm limit with hysteresis

The alarm is triggered when the process value undershoots the Lower Alarm Limit (1). The alarm is cleared when the process value overshoots the Lower Alarm Limit plus hysteresis (2).

C: Lower alarm limit without hysteresis

The alarm is triggered when the process value undershoots the Lower Alarm Limit (1). The alarm is cleared when the process value overshoots the Lower Alarm Limit (2).

D: Upper alarm limit without hysteresis

The alarm is triggered when the process value overshoots the Upper Alarm Limit (1). The alarm is cleared when the process value undershoots the Upper Alarm Limit (2).

NOTE:

Flow direction warning

The limit function can be used to signal the flow direction by setting the Lower Limit Warning for the Process Value to 0. A warning will occur in case of negative flow

All alarms and warnings can be signaled on the output if Status Mode is set to Individual alarms, see “Digital Output” (chapter 8.6.6, page 115).

Limit behavior on the outputs

Process Alarms can trigger Fail Safe behavior on the Signal Output, whereas Process Warnings are only used as information available in HMI and on the communication. Process value will bring the Signal output to Fail Safe mode if:

- Signal Output is configured to Current, Pulse or Frequency
- Fail Safe Mode is configure to react on a failure
- Process Alarm occurs on a process value selected on the output

The alarm behavior is described in detail below.

Detail alarm behavior is described in “Device Status Symbols” (chapter 10.1, page 134).

Hysteresis is used to adjust the tolerance by undershooting or overshooting the limit as described below.



8.1.3. Process Value Derivations

The sensor module of the transmitter processes the signals of the Coriolis sensor and calculates process variables. The time period of vibration of the two measuring tubes is inversely proportional to their frequency, which is used to determine density. The average difference in phase of the two measuring tubes is dependent upon the mass flowrate of the process medium. In this measurement context, phase difference is expressed not in degrees of rotation but as absolute time measurement and a mass flow rate is also converted. The result of zero offset correction is displayed in kg/s.

The process variables are interrelated and derived in the following fashions:

- Mass flow: proportional to the phase difference between pickup 1 and pickup 2, with compensations for changes in the metal characteristics due to tube metal temperatures.¹⁰⁾
- Volume flow: derived directly from the ratio of massflow and media density.
- Standard volume flow: derived from the ratio of massflow and standard density.¹¹⁾
- Density: derived from the average frequency of measuring tube vibration with compensation for changes in the metal characteristics with tube temperature. The relationship between density and vibration frequency is an inverse square-law curve which can be fitted up to 3 reference points being the densities of air, hot water and cold water.
- Process media temperature: derived from the tube metal temperature. This is a legitimate measurement outcome since the tube walls are thin and they are within a sealed, protected environment, thereby giving similar sensitivity as an insertion thermometer.
- Fraction A (massflow or volumeflow): derived from the combination of media density and temperature, and compared with a stored table of fraction percentage against a wide range of both process values through a fifth-order polynomial.¹²⁾
- Fraction B (massflow or volumeflow): ditto but fraction B is "Flow – A"
- Fraction A %: as for fraction A quantity but A% is the ratio between Fraction A flow and Total flow
- Fraction B %: ditto but B% is "100 % – A %"

¹⁰⁾ Metal temperatures are measured using precision Pt1000 sensors. The accuracy of the temperature measurement is $\pm 1 \text{ }^\circ\text{C}$ [$\pm 1.8 \text{ }^\circ\text{F}$].

¹¹⁾ Standard density is the density of the media at reference conditions, normally atmospheric pressure and $20 \text{ }^\circ\text{C}$ [$68 \text{ }^\circ\text{F}$]. Standard density can be programmed into the flow meter menu in two forms, either as a fixed reference or with a selection of linear or square-law temperature dependence. The choice of fixed or calculated standard density and of linear or square-law temperature dependency is according to the application and user preferences.

¹²⁾ The customer-specified density/temperature tables may be derived from the mass fraction or volume fraction of any two-part mixture. Fraction calculations are naturally performed in the ratio provided, or in mass ratio when using the built-in tables. Volume or mass ratios derived from the fraction table are calculated through the composite media density.

8.2. Zero Point Adjustment

In the following the automatic zero point adjustment function is described. For further details, see the appendix Zero point adjustment.

NOTE:**Preconditions**

Before a zero point adjustment is initiated, the pipe must be flushed, filled and at an absolute flowrate of zero preferably also at operating pressure and temperature. Refer to "Zero point adjustment" via HMI.

NOTE:**Change of parameters during zero point adjustment**

Do not change any other parameter during the zero point adjustment procedure.

Automatic zero point adjustment

The device measures and calculates the correct zero point automatically.

The automatic zero point adjustment of the flow meter is set by the following parameters:

- Duration
- Start Zero Point Adjustment

When zero adjust is initiated by selecting "Start Zero Point Adjustment", the massflow values are acquired and totalized for the configured period (Duration). The default zero point adjustment period (30 s.) is normally sufficient for a stable zero point measurement.

NOTE:**Extremely low flow quantity**

If the flow quantity is extremely small, extremely precise measurement is necessary. In this case, a long zero point adjustment period can be selected for improved zero point adjustment.

Zero point calculation

During zero point adjustment, a time average value is calculated. The resultant flow value represents an offset from true zero flow. The standard deviation is also calculated as a parameter of the measured value stability.

Successful automatic zero point adjustment

If the new zero point offset value is valid, it is automatically stored as the new zero point for the sensor. It remains stored in the case of a power failure.



Manual zero point adjustment

In case an automatic zero point adjustment cannot be performed, it is possible to do a manual zero point adjustment by entering the zero point offset value.

1. Select "Manual" in "Select Zero Point Adj." (menu item 2.6.1).
2. Enter the desired value in "Offset" (menu item 2.6.8).

8.3. Low Flow Cut-Off

In certain applications, as for instance dosing applications, 0% flow signals below a certain flowrate are desired. In these applications, the flow signal can be forced to zero, when the flow is lower than a predefined flow value (Low Flow Cut-Off).

The device provides two parameters for setting the low flow cut-off:

- Low Mass Flow Cut-Off
- Low Volume Flow Cut-Off

The low flow cut-off parameters influence all outputs of the device, for example Local User Interface, Channel 1 to 4, and bus communication outputs.

Depending on the process values selection of the output either Low Mass Flow Cut-Off or Low Volume Flow Cut-Off will influence the output.

8.4. Empty Tube Monitoring

The empty tube monitoring function uses the process density for detecting an empty tube. Use of this function is recommended for all standard applications.

NOTE:

Gas applications

Deactivate the empty tube monitoring function.

Empty tube monitoring parameters

Two parameters for setting the empty tube monitoring function are available:

- Empty Tube Detection (Modbus address 2129)
- Empty Tube Limit (Modbus address 2127)

The empty tube monitoring is activated via the Empty Tube Detection parameter. When the empty tube monitoring function is on, the massflow/volumeflow value is forced to zero if the tube is empty.

The tube is defined as empty, if the measured density value is lower than the value defined via the Empty Tube Limit parameter.

NOTE:

Process media density

Risk of unintentionally forcing flow values to zero, if the difference between the empty tube limit density value and the density of the process media is not sufficient.

Ensure sufficient difference between the empty tube limit density value and the process media density

8.5. Process Noise Damping

Noise damping function

The dynamic sensitivity of the flow measurement signal to rapid changes in process flows can be reduced by use of the process noise damping function. The function is typically used in environment with:

- Strongly pulsating flow
- Changing pump speeds
- Large pressure variations

Process noise damping settings

Reduce interfering process noise by increasing the setting of the parameter "Process Noise Damping".

- Centrifugal pump (1: low)
- Triplex pump (2)
- Duplex pump (3)
- Simplex pump (4)
- Cam pump (5: high)

The default value is "Duplex pump". The damping affects all functions and outputs of the sensor.



Fig. 76: Centrifugal pump (1: low)

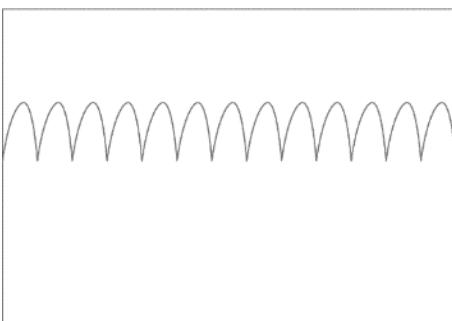

Fig. 77: Triplex pump (2)

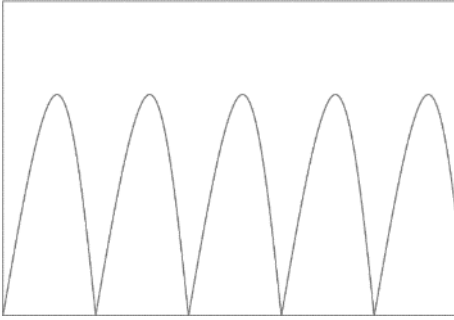

Fig. 78: Duplex pump (3; default setting)

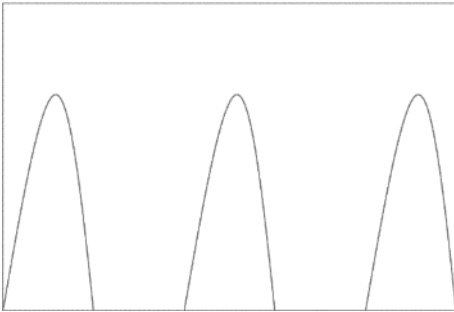

Fig. 79: Simplex pump (4)

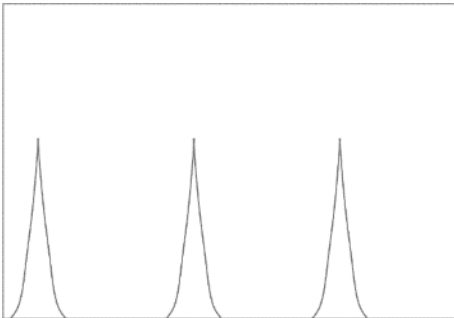

Fig. 80: Cam pump (5: high)

NOTE:

Increased reaction time

The reaction time of the sensor increases when the process noise is damped/filtered.



8.6. Inputs and Outputs

The hardware functionality of input and output is fixed when ordering the product. The available configuration is described in the following table:

Channel	HW Configuration (fixed when ordering)	SW Configuration (available to the user)
1	Current output (4 ... 20 mA) HART, Modbus, PROFIBUS DP, PROFIBUS PA	
2	Signal output	<ul style="list-style-type: none"> • Current (0/4 ... 20 mA) • Frequency or pulse • Three-stage analog valve dosing control • Discrete one or two-valve dosing control • Operational and alarm status
3	Signal output	<ul style="list-style-type: none"> • Current (0/4 ... 20 mA) • Frequency or pulse • Redundant frequency or pulse (together with channel 2) • Three-stage analog valve dosing control • Discrete one or two-valve dosing control • Operational and alarm status
	Signal input	<ul style="list-style-type: none"> • Dosing control • Totalizer reset • Remote zero adjust • Force or freeze output(s)
4	Signal output	<ul style="list-style-type: none"> • Current (0/4 ... 20 mA) • Frequency or pulse • Three-stage analog valve dosing control • Discrete one or two-valve dosing control • Operational and alarm status
	Relay output	<ul style="list-style-type: none"> • Discrete one or two-valve dosing control • Operational and alarm status
	Signal input	<ul style="list-style-type: none"> • Dosing control • Totalizer reset • Remote zero adjust • Force or freeze output(s)

Tab. 23: Available configuration hardware functionality of input and output



8.6.1. Current Output

All four channels can be configured as current output.

Current output configuration

The following process values can be assigned to the current output:

- Mass flow
- Volume flow
- Standard volume flow
- Density
- Temperature
- Fraction A (Volume flow or Mass flow)
- Fraction B (Volume flow or Mass flow)
- Fraction A %
- Fraction B %
- Control valve *

The process variable listed above with * is not available to be allocated to the 4 to 20 mA output on Channel 1. All process variables are available through bus communication (SV, TV and QV variables) and on all of Channels 2 to 4.

The accuracy specified for the analog output signal applies only within the range 4 to 20 mA. Lower limit (4 mA) and upper limit (20 mA) can be assigned to any specific flow values.

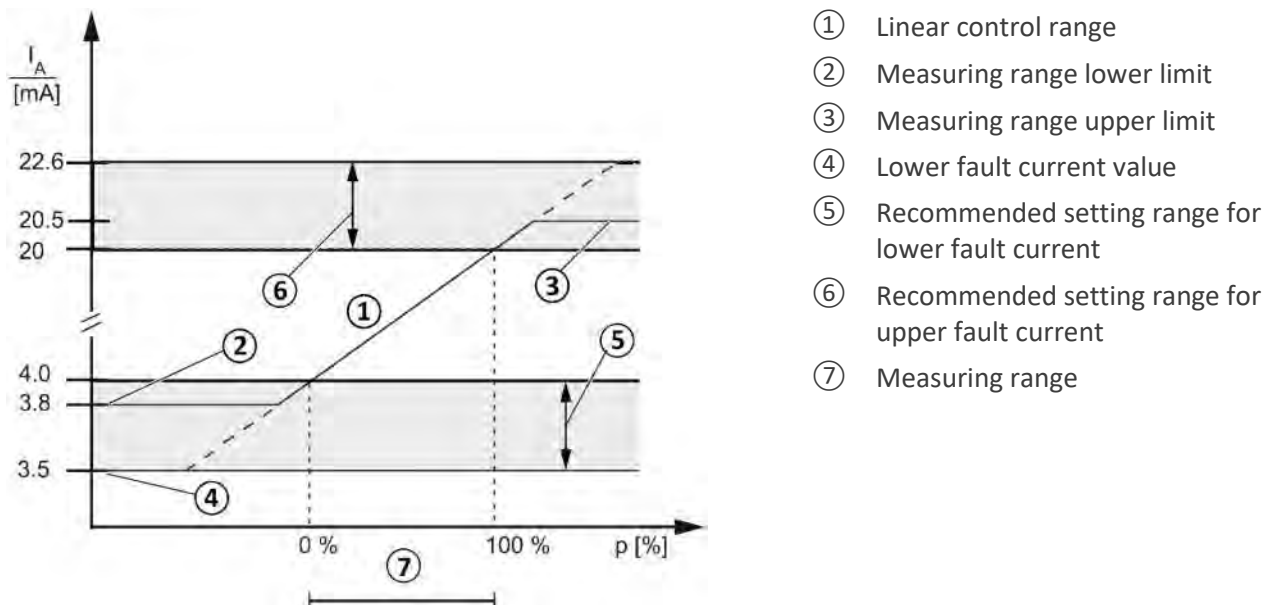

Fig. 81: Current limits for NAMUR configuration



The fail safe current output signal can be selected to:

- Minimum Current (defined in the Current Mode selection)
- Maximum Current (defined in the Current Mode selection)
- Last Good Value (the last process value before the failure occurred)
- Current Value (actual measured value)
- User defined (within the range of 0 mA to 25 mA¹³⁾)

In the alarms lists in “Sensor Diagnostic Events” (chapter 10.2.1, page 136) it is listed which alarms bring the output to fail safe current.

Output scaling configuration

Below are four examples describing configuration possibilities for a current output.

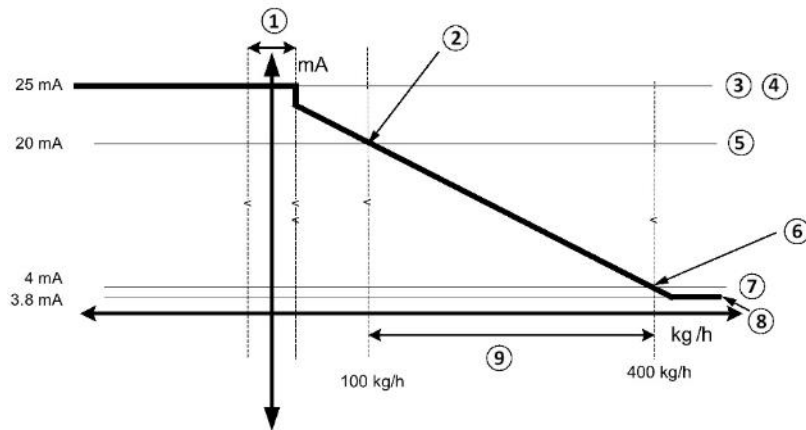

Fig. 82: Positive flow with negative scaling

- ① Low-flow cut-off
- ② Upper scaling
- ③ Maximum output current
- ④ Upper alarm current
- ⑤ Upper range
- ⑥ Lower scaling
- ⑦ Lower range
- ⑧ Minimum output current
- ⑨ Measurement range

¹³⁾ For channel 1 the range is 3.5 mA to 25 mA



Current output setting

- Process value = Mass flow
- Direction = Symmetric
- Current Mode = 4 ... 20 mA (maximum 25 mA)
- Upper Scaling = 400 kg/h
- Lower Scaling = -100 kg/h
- Fail Safe Mode = Maximum current
- Low-Flow Cut-Off = 25 kg/h

Positive flow across zero with positive scaling

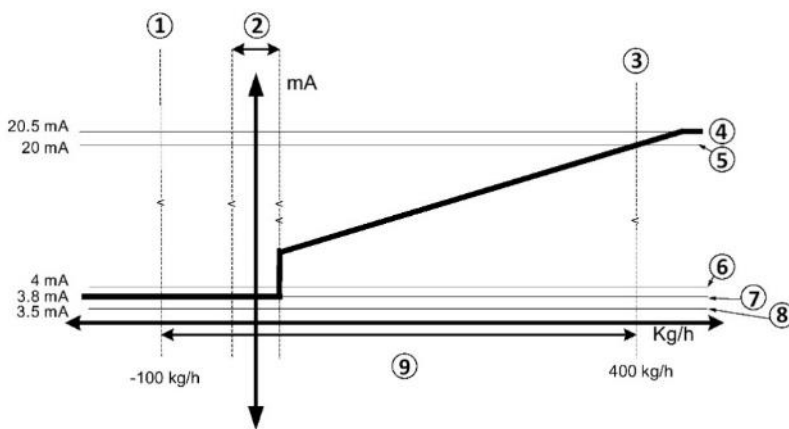

Fig. 83: Positive flow across zero with positive scaling

- ① Lower scaling
- ② Low-flow cut-off
- ③ Upper scaling
- ④ Maximum measurement value
- ⑤ Upper range
- ⑥ Lower range
- ⑦ Minimum measurement value
- ⑧ Lower alarm value
- ⑨ Measurement range

Current output setting

- Process value = Massflow
- Direction = Bidirectional
- Current Mode = 4 ... 20 mA NAMUR
- Upper Scaling = 400 kg/h
- Lower Scaling = -100 kg/h
- Fail Safe Mode = Maximum current
- Low-Flow Cut-Off = 25 kg/h

Bidirectional flow across zero with positive scaling

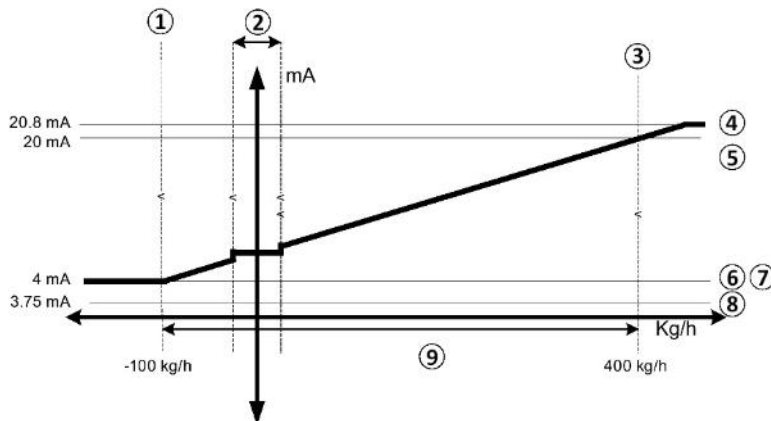

Fig. 84: Bidirectional flow across zero with positive scaling

- ① Lower scaling
- ② Low-flow cut-off
- ③ Upper scaling
- ④ Maximum measurement value
- ⑤ Upper range
- ⑥ Lower range
- ⑦ Minimum measurement value
- ⑧ Lower alarm value
- ⑨ Measurement range

Current output setting

- Process value = Massflow
- Direction = Bidirectional
- Current Mode = 4 ... 20 mA US
- Upper Scaling = 400 kg/h
- Lower Scaling = -100 kg/h
- Fail Safe Mode = Minimum current
- Low-Flow Cut-Off = 25 kg/h



Bidirectional flow with symmetrical scaling

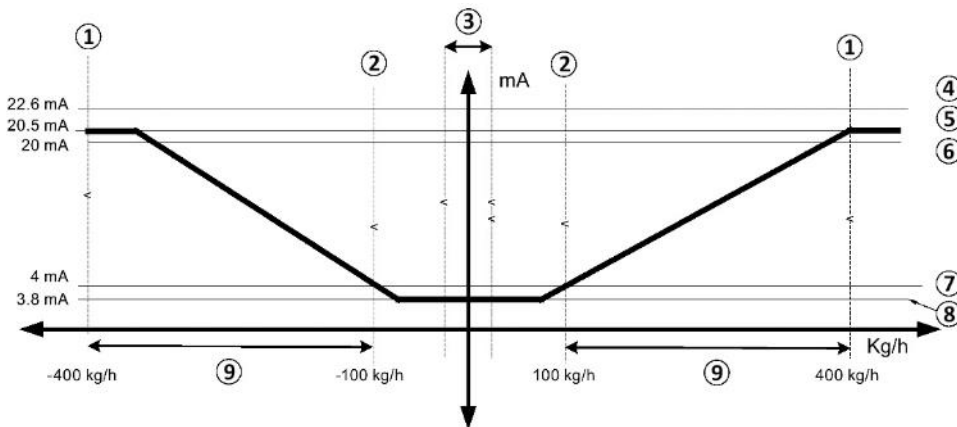

Fig. 85: Bidirectional flow with symmetrical scaling

- ① Upper scaling
- ② Lower scaling
- ③ Low-flow cut-off
- ④ Upper alarm value
- ⑤ Maximum measurement value
- ⑥ Upper range
- ⑦ Lower range
- ⑧ Minimum measurement value
- ⑨ Measurement range

Current output setting

- Process value = Massflow
- Direction = Bidirectional (Symmetric)
- Current Mode = 4 ... 20 mA NAMUR
- Upper Scaling = 400 kg/h
- Lower Scaling = 100 kg/h
- Fail Safe Mode = Maximum current
- Low-Flow Cut-Off = 25 kg/h

8.6.2. Pulse Output

The pulse output function supplies pulses equivalent to a certain amount of accumulated volume or mass. The pulse width is configurable and the pulse repetition is proportional to the selected flow rate.

Pulse repetition

Pulse repetition is calculated as follows:

$$\text{Pulse repetition} = \frac{\text{Amount per pulse}}{\text{Measured flow rate}}$$

NOTE:

Pulse width must be selected with the view that remaining time is always greater than pulse width at the highest measured flow.

Example

- Pulse output configuration (channels 2 to 4)
 - Operation Mode = Pulse Output
 - Process Value = Massflow
 - Amount Per Pulse = 1 kg
 - Pulse Width = 1 ms
- Measured massflow value = 10 kg/s (constant)

Result:

- Pulse repetition = 100 ms
- Output frequency = 10 pulses per second with a pulse width of 1 ms
- Remaining time between pulses is 99 ms

8.6.3. Frequency Output

The frequency output function supplies a frequency (50% duty cycle) proportional to the selected process value.

Frequency is calculated as follows:

$$\text{Frequency} = \frac{\text{Measured massflow value}}{\text{Flow Value High} - \text{Flow Value Low}} * (\text{Frequency Value High} - \text{Frequency Value Low})$$



Example

This example shows how to calculate the output frequency for any measured flowrate:

Frequency output configuration:

- Operation Mode = Frequency Output (Channel 2 to 4)
- Process Value = Massflow
- Direction = Positive
- Frequency Value High = 12 kHz
- Frequency Value Low = 2 kHz
- Flow Value High = 15 kg/s
- Flow Value Low = 5 kg/s

Measured massflow value = 7.5 kg/s (constant)

Result:

- Frequency = 4.5 kHz

NOTE:

The connected equipment must be capable of registering the full range of frequencies configured.

8.6.4. Redundancy Mode (frequency)

If both channel 2 and channel 3 are configured as frequency outputs, channel 3 can be configured for redundancy mode to follow channel 2 shifted by 90° or 180°. If set to redundancy mode, channel 3 inherits all channel 2 settings. The flow direction will determine whether channel 3 is shifted before or after channel 2 at 90° shift.

The following examples describe the frequency functionalities for channel 2 and 3 in redundancy mode:

Channel 2 configured as positive direction and channel 3 set to redundancy mode 90°

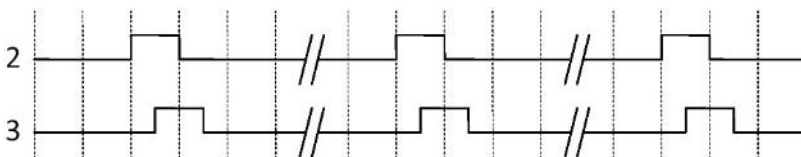

Fig. 86: Positive flow - Channel 3 leads by 90°

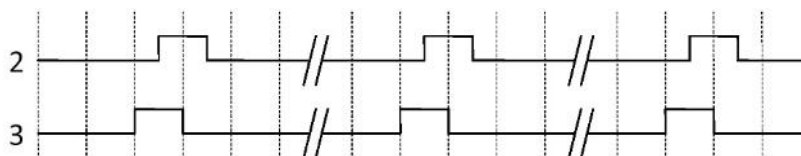

Fig. 87: Negative flow - Channel 3 lags by 90°

Channel 2 configured as positive direction and channel 3 set to redundancy mode 180°

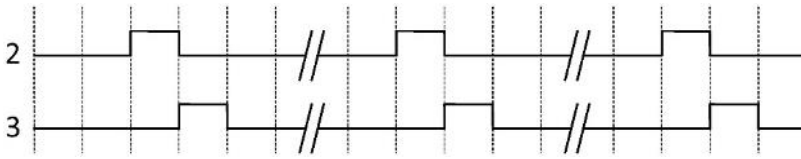

Fig. 88: Positive flow - Channel 3 leads by 180°

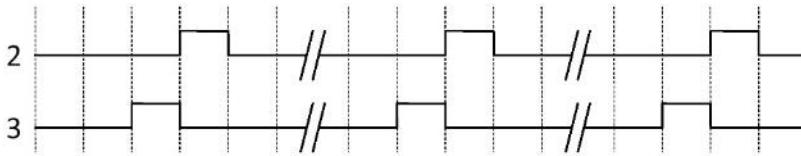

Fig. 89: Negative flow - Channel 3 lags by 180°

8.6.5. Redundancy Mode (pulse)

If both channel 2 and channel 3 are configured as pulse outputs, channel 3 can be configured for redundancy mode to follow channel 2 shifted by 90° or 180° of the functional width of the pulse. If set to redundancy mode, channel 3 inherits all channel 2 settings. The functional width of the pulse is two times the pulse "On" duration. The flow direction will determine whether channel 3 is shifted before or after channel 2.

The following examples describe the pulse functionalities for channel 2 and 3 in redundancy mode:

Channel 2 configured as positive direction and channel 3 set to redundancy mode 90°

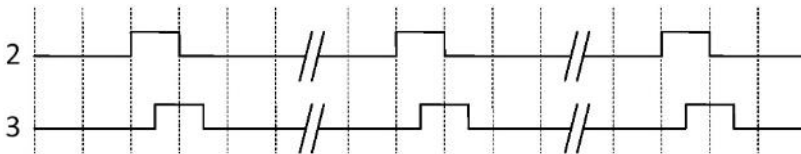

Fig. 90: Positive flow - Channel 3 leads by 90°

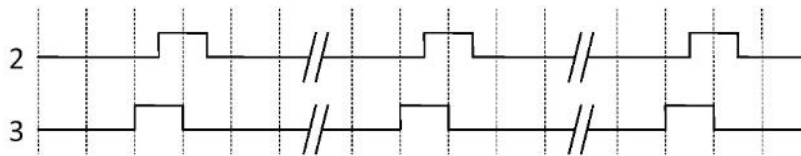

Fig. 91: Negative flow - Channel 3 lags by 90°



Channel 2 configured as positive direction and channel 3 set to redundancy mode 180°

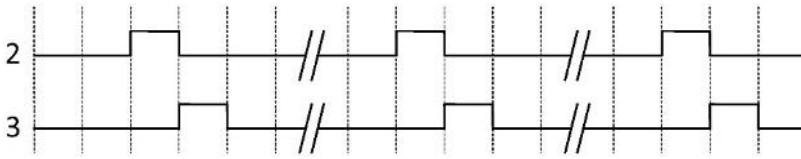

Fig. 92: Positive flow - Channel 3 leads by 180°

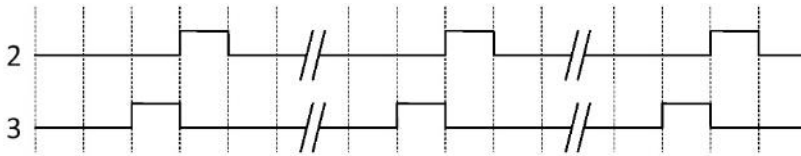

Fig. 93: Negative flow - Channel 3 lags by 180°

8.6.6. Digital Output

The status output can be used to show alarm status or to control the dosing and it can be signaled on Signal Output or Relay Output.

Depending on the Alarm Mode setting, multiple alarms can be signaled on the output and selected from the alarm class or the Individual alarms lists.

- Alarm Class: Alarm will be signaled if alarm within the selected alarm class occurs.
- Individual alarms: Alarm will be signaled if selected Individual alarms occurs. It is possible to select more multiple alarms to be signaled.

NOTE:

Alarm class

The alarm class options depend on the Alarm Mode setting, either NAMUR or Standard (TRICOR Standard), selected in menu item 3.2.1. Both NAMUR and TRICOR Standard alarms and their messages are described in more detail in “Sensor Diagnostic Events” (chapter 10.2.1, page 136).

The control output can be used for controlling discrete valve dosing and analog valve dosing as described in “Dosing” (chapter 8.8, page 116).

8.6.7. Input

If the input is activated with a logic signal (15 - 30 V DC), the meter carries out an activity selected in the menu.

The following input options are available:

- Start dosing
- Hold/continue dosing
 - When this function is activated, it will pause the dosing. When it is deactivated, the dosing will continue



- Stop dosing
 - Sets the digital output to "Off" and resets the dosing counter
- Zero adjust
 - Starts the automatic zero point adjustment. This function employs the existing configurations and presumes that the process conditions are prepared for the zero point adjustment routine
- Reset totalizer
 - Resets one of the internal totalizers 1, 2 or 3 (depending on configuration)
- Resets all totalizers simultaneously
- Freeze signal
 - Freezes all currently measured values in the display and outputs
- Force signal
 - Forces all outputs to adopt the value selected in the menu. If the value 100% is selected, the current output will show 20 mA and the frequency output will show 10.000 kHz when the external output is activated

WARNING!

Changing polarity

Changing the polarity triggers the signal input to execute the set functionality.

8.7. Totalizers

8.7.1. Totalizer Functions

The device has three independent totalizers that can be used to total the massflow, volumeflow, corrected volumeflow, fraction A (volumeflow or massflow) or fraction B (volumeflow or massflow).

The totalizers can be configured to count balance (net flow), positive flow or negative flow.

In case of failure in the system, the totalizer fail safe mode can be set to:

- Hold (default): the totalizer holds the last value before the failure occurred
- Run: the totalizer continues counting the actual measured value
- Memory: the totalizer continues counting based on the last input value (for example massflow) before the failure occurred.

The totalizers can be operated via the Local User Interface or bus communication. The totalizers can be reset or preset.

8.8. Dosing

The dosing function controls the sequence of flow through one or two valves into a container. The user can set the Amount and the sequence of controlling the valve(s). The dosing function then controls the valves to open and close in sequence to achieve the Amount.

The process values for dosing control are updated with 100 Hz to ensure maximum response time of 10 ms to rapidly changing flows.

The flow sequence can be paused, resumed and ended by the user at any point in the flow sequence.



Transmitter outputs therefore change state according to the dosing sequence or operator commands. For optimal dosing control the minimum number of components between the flow meter and the dosing valves must be employed. The dosing function must be configured for the type of valve used for dosing:

- One on/off valve:
Dosing controlled by a single discrete (Open/Closed) valve. The valve opens completely when the dosing begins, and closes completely when the dosing Amount is reached.
- Two on/off valves:
Dosing controlled by two discrete valves (a primary valve and a secondary valve). One valve opens at the beginning of the dosing; the other opens at a user-defined amount. One valve stays open until the end of the dosing; the other closes at a user-defined amount. See examples below (chapter 8.8.2, page 118) of some different opening and closing options.
- Control valve:
Dosing controlled by an analog valve configured in three stages as fully open, partially closed, and fully closed. See example below (chapter 8.8.2, page 118) of the three-positional Control valve.

Dosing setup procedure

The dosing functionality is configured via HMI. Menu 2.4 "Inputs/Outputs" determines how the transmitter will use the inputs and outputs for dosing control. Menu 2.5 "Dosing" independently determines the sequencing of the outputs to achieve the user's desired result.

The dosing function provides:

- three dosing valve control mechanisms (One on/off valve, Two on/off valves or Control valve)
- dosing of mass flow, volume flow, standard volume flow or fraction flow (mass or volume)
- five independently configurable recipes
- flexible discrete or analog valve control
- fault handling: time and amount monitoring

Configure the dosing function as follows:

1. Basic dosing parameters in menu 2.5 "Dosing"
 - Select valve control functionality at parameter "Dosing Mode"
 - Select measured process value for dosing at parameter "Process Values"
2. Individual recipe(s) in menus 2.5.4 to 2.5.8 as required
 - Setup dosing name, amount, unit and compensation
 - Select valve control sequence
 - Select fault handling configuration
3. Output(s) in menu 2.4 "Inputs/Outputs" (see table below).
4. Input for dosing control in menu 2.4 "Inputs/Outputs"



8.8.1. Dosing Control Configuration

Dosing control includes valve control (discrete/analog) and fault handling. The valve control is done using channels 2, 3 and 4. Dosing control can be configured to:

- One on/off valve
- Two on/off valves
- Control valve

One on/off valve

Use one Signal or one Relay output to control the one-stage dosing. Set the Operating Mode of signal output to Status. Assign Status Mode to control the Primary Valve. A Signal Input can be assigned to start the dosing.

Two on/off valves

Use two Signal outputs to control the two-stage dosing. Set the Operating Mode of signal output to Status. Assign one Status Mode to control the Primary Valve and the other to control the Secondary Valve. A Signal Input can be assigned to start the dosing.

Control valve

Use one Signal output to control the Control valve. Assign the Operating Mode to Current Output. A Signal Input can be assigned to start the dosing.

Process Values

The following process values can be used for dosing control:

- Mass flow
- Volume flow
- Standard volume flow
- Fraction A
- Fraction B

Recipes

Five recipes can be configured individually, however only one of the recipes can be active at a time.

8.8.2. Valve Control Configuration

8.8.2.1. Valve Control Dosing

Dosing is controlled with either one or two discrete valves or a single analog valve. The transmitter provides up to three input/output channels which can be used for dosing control. The selection of channels is fixed when ordering the system. The channels can be setup for dosing functionality in parameter 2.5.1 "Dosing Mode" as shown in the table below. Allocation of the output to a specific dosing sequence element is performed in the software configuration as follows:



8.8.2.2. One On/Off Valve

Configuration of one valve (primary valve).

One of the following channels must be assigned to control the discrete primary valve.

Valve Control	Channel HW Configuration	Output Channel	Channel SW Configuration		
			Menu Item	Value	
Discrete Valve Control - Primary Valve	Signal Output	2	2.4.2.1	"Operation Mode"	Status Output
			2.4.2.27	"Status Mode"	Primary Valve Dosing
		3	2.4.3.1	"Operation Mode"	Status Output
			2.4.3.29	"Status Mode"	Primary Valve Dosing
		4	2.4.6.1	"Operation Mode"	Status Output
			2.4.6.27	"Status Mode"	Primary Valve Dosing
	Relay Output	4	2.4.4.1	"Status Mode"	Primary Valve Dosing

Tab. 24: One on/off valve

8.8.2.3. Two on/off valves

Configuration of two valves (primary and secondary valves)

One of the following channels must be assigned to control the discrete primary valve and one must be assigned to control the secondary discrete valve.

Valve Control	Channel HW Configuration	Output Channel	Channel SW Configuration		
			Menu Item	Value	
Discrete Valve Control - Primary Valve	Signal Output	2	2.4.2.1	"Operation Mode"	Status Output
			2.4.2.27	"Status Mode"	Primary Valve Dosing
		3	2.4.3.1	"Operation Mode"	Status Output
			2.4.3.29	"Status Mode"	Primary Valve Dosing
		4	2.4.6.1	"Operation Mode"	Status Output
			2.4.6.27	"Status Mode"	Primary Valve Dosing
	Relay Output	4	2.4.4.1	"Status Mode"	Primary Valve Dosing
	Discrete Valve Control - Secondary Valve	Signal Output	2	2.4.2.1	"Operation Mode"
2.4.2.27				"Status Mode"	Secondary Valve Dosing
3			2.4.3.1	"Operation Mode"	Status Output
			2.4.3.29	"Status Mode"	Secondary Valve Dosing
4			2.4.6.1	"Operation Mode"	Status Output
			2.4.6.27	"Status Mode"	Secondary Valve Dosing
Relay Output		4	2.4.4.1	"Status Mode"	Secondary Valve Dosing

Tab. 25: Two on/off valves

8.8.2.4. Control Valve

Configuration of one analog valve.

One of the following channels must be assigned to control the analog valve.

Dosing Mode	Valve Control	Channel HW Configuration	Output Channel	Channel SW Configuration		
				Menu Item	Value	
Control Valve	Analog	Signal Output	2	2.4.2.1	"Operating Mode"	Current Output
				2.4.2.2	"Process Value"	Control valve
			3	2.4.3.1	"Operating Mode"	Current Output
				2.4.3.2	"Process Value"	Control valve
			4	2.4.6.1	"Operating Mode"	Current Output
				2.4.6.2	"Process Value"	Control valve

Tab. 26: Control valve

NOTE:

If the output channels including current output are configured for valve control, they cannot report alarm status or fault levels.

Valve control parameter configured	Default values	Description
Stage 1 Primary Open	0.00 % of Amount	The quantity or percent of the Amount at which the primary valve will open
Stage 1 Primary Close	80.00 % of Amount	The quantity or percent of the Amount at which the primary valve will close
Stage 2 Secondary Open	20.00 % of Amount	The quantity or percent of the Amount at which the secondary valve will open
Stage 2 Secondary Close	100.00 % of Amount	The quantity or percent of the Amount at which the secondary valve will close

Tab. 27: Parameter settings for two on/off valves valve control

Either Stage 1 Primary Open or Stage 2 Secondary Open must be set to 0. For controlling the valves via the outputs, two of channels 2, 3 and 4 must be assigned to Primary Valve Dosing Control and Secondary Valve Dosing control, respectively.

Either Stage 1 Primary Close or Stage 2 Secondary Close must be set to Amount.

In the example below primary valve, secondary valve, and flow are indicated as follows:

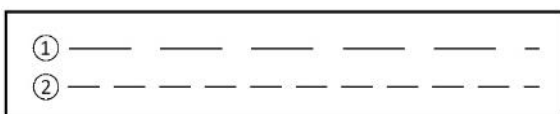

① Primary valve

② Secondary valve



8.8.2.5. Examples of Valve Control Configuration

Example 1:

Open primary valve at 0 %; close primary valve before closing secondary valve configured in recipe 1

Parameter configuration:

Menu 2.5 Dosing

- 2.5.1 Dosing Mode = Two on/off valves

Menu 2.5.5.6 Valve Control

- 2.5.5.6.1 Stage Setup Format = Relative
- 2.5.5.6.2 Stage 1 Primary Open = 0 %
- 2.5.5.6.3 Stage 1 Primary Close = 66 %
- 2.5.5.6.4 Stage 2 Secondary Open = 33 %
- 2.5.5.6.5 Stage 2 Secondary Close = 100 %

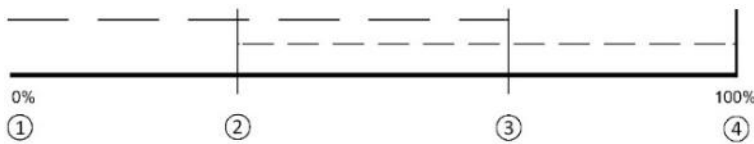

- ① Open primary valve
- ② Open secondary valve
- ③ Close primary valve
- ④ Close secondary valve

Example 2:

Open primary valve at 0 %; close primary valve after closing secondary valve configured in recipe 1

Parameter configuration:

Menu 2.5 Dosing

- 2.5.1 Dosing Mode = Two on/off valves

Menu 2.5.5.6 Valve Control

- 2.5.5.6.1 Stage Setup Format = Relative
- 2.5.5.6.2 Stage 1 Primary Open = 0 %
- 2.5.5.6.3 Stage 1 Primary Close = 100 %
- 2.5.5.6.4 Stage 2 Secondary Open = 33 %
- 2.5.5.6.5 Stage 2 Secondary Close = 66 %

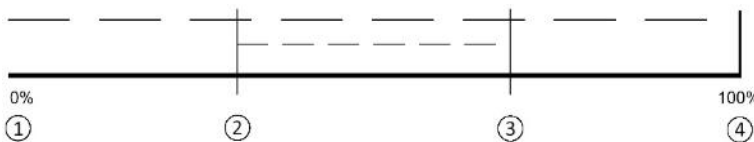

- ① Open primary valve
- ② Open secondary valve
- ③ Close secondary valve
- ④ Close primary valve

Example 3:

Open secondary valve at 0 %; close primary valve before closing secondary valve configured in recipe 1

Parameter configuration:

Menu 2.5 Dosing

- 2.5.1 Dosing Mode = Two on/off valves

Menu 2.5.5.6 Valve Control

- 2.5.5.6.1 Stage Setup Format = Relative
- 2.5.5.6.2 Stage 1 Primary Open = 33 %
- 2.5.5.6.3 Stage 1 Primary Close = 66 %
- 2.5.5.6.4 Stage 2 Secondary Open = 0 %
- 2.5.5.6.5 Stage 2 Secondary Close = 100 %

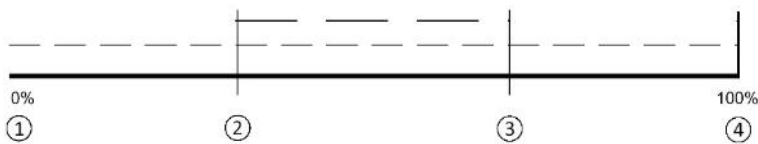

- ① Open secondary valve
- ② Open primary valve
- ③ Close primary valve
- ④ Close secondary valve

Example 4:

Open secondary valve at 0 %; close primary valve after closing secondary valve configured in recipe 1

Parameter configuration:

Menu 2.5 Dosing

- 2.5.1 Dosing Mode = Two on/off valves

Menu 2.5.5.6 Valve Control

- 2.5.5.6.1 Stage Setup Format = Relative
- 2.5.5.6.2 Stage 1 Primary Open = 33 %
- 2.5.5.6.3 Stage 1 Primary Close = 100 %
- 2.5.5.6.4 Stage 2 Secondary Open = 0 %
- 2.5.5.6.5 Stage 2 Secondary Close = 66 %

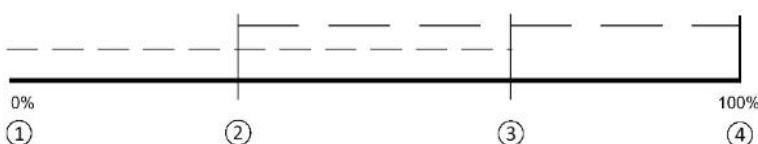

- ① Open secondary valve
- ② Open primary valve
- ③ Close secondary valve
- ④ Close primary valve



Control valve:

Dosing controlled by an analog valve configured in three stages as fully open (high flow), partially open, and fully closed. During the open stage the valve may be not fully open but controlled to a high flow condition.

Valve Control Parameter Configured	Default Value	Description
Fully Closed Current Level	0 mA	The output current which defines the closed valve state
Partial Open Current Level	10 mA	The output current which defines the partially open valve state
Fully Open Current Level	20 mA	The output current which defines the high flow valve state
Fully Open	0.00 % of Amount	The quantity or percent of amount at which the valve will transition from partial to full flow
Partially Closed	100.00 % of Amount	The quantity or percent of amount at which the valve will transition from full flow to partial flow

Tab. 28: Valve control parameter

8.8.2.6. Three-positional Control Valve Configured in Recipe 1

Parameter configuration:

Menu 2.5 Dosing

- 2.5.1 Dosing Mode = Control valve

Menu 2.5.4.5 Valve Control

- 2.5.4.5.1 Stage Setup Format = Relative
- 2.5.4.5.6 Fully Closed Current Level = 0 mA
- 2.5.4.5.7 Partial Open Current Level = 10 mA
- 2.5.4.5.8 Fully Open Current Level = 20 mA
- 2.5.4.5.9 Fully Open = 35 %
- 2.5.4.5.10 Partially Closed = 65 %

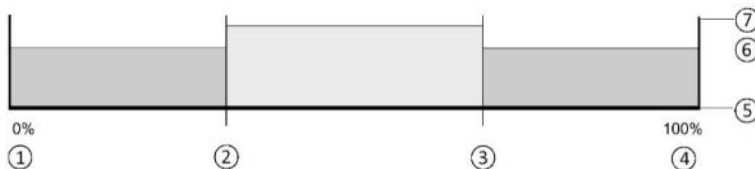

- ① Partially open valve
- ② Fully open valve (35%)
- ③ Partially open valve (65%)
- ④ Fully closed valve
- ⑤ No flow
- ⑥ Partial flow
- ⑦ Full flow



8.8.3. Dosing Operation

When the transmitter recipes have been configured, the active recipe is selected in parameter 2.5.3 "Active Recipe". The transmitter output changes according to the dosing operation and controls the valve. The digital input can be configured to start dosing. HMI provides dosing control via the dosing operating view. All dosing setup and control can be performed via bus communication using as well.

Dosing compensation

In static applications the flowrate is constant. Thus, the dosing compensation, if required, is fixed. Use the fixed compensation by entering the amount in menu item 2.5.5.5.2 (Fixed Compensation).

8.8.4. Fault Handling

The transmitter fault handling provides monitoring of both dosing time and amount. The configuration of the fault handling is done in menu 2.5.4.6 Fault Handling.

Dosing timeout monitoring

The dosing timeout monitoring checks whether the dosing procedure has been finished within the configured Duration Time (menu item 2.5.5.7.2 for Recipe 1). If the duration time is exceeded, an alarm will be triggered, see "Fault Codes and Corrective Actions" (chapter 10.2, page 136).

Dosing overrun monitoring

The dosing overrun monitoring checks if the flow amount exceeds the defined Overrun Value (menu item 2.5.5.7.3 for Recipe 1). If the overrun value is exceeded, an alarm will be triggered, see "Fault Codes and Corrective Actions" (chapter 10.2, page 136).

This function can detect a valve malfunction (non-closure) caused by a blockage, wear, etc.

8.9. Audit Trail Logging

The audit trail includes any values or settings changed by users. The audit trail is automatically stored with information on the change as well as the time (real-time) and by which interface (display or bus communication) the change was made.

Audit trail information is logged on the SD-Card, as a parameter and command change file which include below informations:

- Timestamp
- MODBUS register
- Previous value
- New value
- Data type
- Interface ID

Example: 2017-06-08 13:48:05;9003;73;74;Uint8;HMI



The transmitter can log up to 100 entries in each of the audit trail log lists:

- "Parameter change log" (menu item 3.9.1)
- "Firmware update change log" (menu item 3.9.3)

Each audit trail list can be cleared by the user.

See also "Diagnostic log" (menu item 3.2.2)

8.10. Diagnostic Log

All unacknowledged diagnostic information are listed in the Diagnostic log menu item 3.2.2

The diagnostic alarm list is default available in operating view 6.

There are two ways to have the alarms removed from the diagnostic list (menu item 3.2.2).

- Manual: The alarm remains in the diagnostic list until the alarm is manually acknowledged (ack.).
The time of the acknowledgement is shown in the Diagnostic log (menu item 3.2.2) as long as the log is not cleared.
- Auto: The alarm is removed from the Diagnostic log when the cause is removed (going)

8.11. Custom Unit

Units can be defined/customized for all process values. This function can be used if the wanted unit cannot be found in the list of units.

Custom unit is defined under each process value, and is available for mass flow, volume flow, standard volume flow, density, fraction and medium temperature.

8.12. SD-Card

The SD-Card is a high-performance micro SD card (4 GB) with the ability to be updated by inserting it in a PC. It is supplied with each sensor with the complete set of certification documents including a calibration report. Material, pressure test, factory testing and order conformance certificates are optional at ordering.

Further it contains parameter backup files, firmware logs, alarm history log, parameter change log and data logging of process values and parameters.

The SD-Card memory unit offers a permanent database with backup of all parameter settings.

The SD-Card supports copy and transfer of user settings from one flow meter to another to simplify commissioning. Only setup parameters are copied; no data are changed in the receiving flow meter.

Copying application setup from one device to another.

1. Remove the SD-Card from the source device and insert the SD-Card into the destination device. The destination device disables the backup and signals an alarm.
2. Enter menu item Copy setups (1.8), select OK and press to execute the copying and move all the application setup parameters from the SD-Card to the device. Backup is still disabled and alarm signaled.
3. Remove the SD-Card from the destination device and insert the original SD-Card. The device synchronizes the parameters to the SD-Card and the alarm is cleared.
4. If there is no SD-card inserted: Insert SD-Card with backup data. Press right key to continue...



5. Please wait...
6. Copy/restore parameterization - succeeded. Press right key to continue...
Or:
Copy/restore parameterization - failed. Press right key to continue...

8.13. Datalogging on the SD-Card

Datalogging of process values can be activated under menu items 3.7 - SD-Card

Data logging can be selected in different logging intervals for Process values and for advanced logging of parameters.

Values with timestamp information is stored on the SD-Card

8.14. Process Peak Values on SD-Card

Process peak values can be activated under menu items 3.5 - peak values

Minimum and maximum process value is stored with timestamp information on the SD-Card, and also under menu items 3.5

8.15. Simulation

Simulation is used for testing purposes, typically for checking that the readings of the control system are correct.

The simulation can be activated in HMI (menu item 3.8).

Inputs/outputs simulation

Depending on the configuration of each input/output the following values can be simulated:

HW Configuration	Channel 1	Channel 2	Channel 3	Channel 4	Simulation Value
Current output	●				4 to 20 mA
Relay output				●	0 (low) or 1 (high)
Signal input			●	●	0 (low) or 1 (high)
Signal output		●	●	●	<ul style="list-style-type: none"> ● 0 to 25 mA ● 0 to 12.5 kHz ● 0 to 12.5 kHz ● 0 (low) or 1 (high)

Tab. 29: Inputs/outputs simulation



Process value simulation

The following process values can be simulated:

- Mass flow
- Volume flow
- Standard Volume flow
- Density
- Process Media Temperature
- Fraction A %
- Fraction B %

Enabling simulation for the process values sets the simulated value for all outputs.

Alarm simulation

It is possible to simulate either specific alarms (ID numbers) or alarm classes. The alarm classes are either TRICOR or NAMUR depending on the configuration of Alarm Mode, menu item 2.8.11.

Any simulated alarms will be time-stamped 1900-01-01 00:00 if the alarms have not previously appeared as real alarms. Any real alarms will be time-stamped with the actual date and time of each alarm occurrence.

All alarms mentioned in “Sensor Diagnostic Events” (chapter 10.2.1, page 136) can be simulated; except ID 51 (Malfunction in Pickup Amplitude) and ID 165 (Ref. density simulated).

8.16. Maintenance

- Set Date and Time
The device has a built-in real-time clock used for time stamps of various events (for example alarms and configuration changes). The date and time can be set in menu item 2.7.2.
- Set To Default
- The device can be reset to its default settings in menu item 3.11.1.
- Restart Device

The device can be restarted without disconnecting the power in menu item 3.11.2.



9. Service and Maintenance

9.1. Basic Safety Notes

NOTE:

The device is maintenance-free.

The device is maintenance-free. However, a periodic inspection according to pertinent directives and regulations must be carried out.

An inspection can include check of:

- Ambient conditions
 - Seal integrity of the process connections, cable entries, and cover screws
 - Reliability of power supply, lightning protection, and grounds
-

WARNING!**Impermissible repair and maintenance of the device**

Repair and maintenance may only be carried out by persons authorised by the manufacturer.

NOTE:**Penetration of moisture into the device**

Device damage.

Make sure when carrying out cleaning and maintenance work that no moisture penetrates the inside of the device.

WARNING!**Leaks**

Risk of poisoning.

When measuring toxic process media, these can be released or collect in the device. Pay attention to the leak tightness of the process line and connections.

Purge the device as described in “Commissioning” (chapter 6, page 63).

Dispose of the toxic process media displaced by purging in an environmentally friendly manner.

CAUTION!**Releasing button lock**

Improper modification of parameters could influence process safety.

Make sure that only authorized personnel may cancel the button locking of devices for safety-related applications.

WARNING!**Use of a computer in a hazardous area**

If the interface to the computer is used in the hazardous area, there is a risk of explosion.

Ensure that the atmosphere is explosion-free (hot work permit).



9.2. Recalibration

KEM Küppers Elektromechanik GmbH and AW-Lake Company offers to recalibrate the sensor in Germany or the USA. The following calibration types are offered as standard according to configuration:

- Standard calibration
- Customer specified calibration
- Calibrations according DIN EN ISO/IEC 17025:2005
- Density calibration (incl. fraction setup if requested)
- Witness calibration

NOTE:

SD-Card

For sensor recalibration the SD-Card memory unit must always be returned with the sensor.

9.3. Cleaning

Cleaning the enclosure

- Clean the outside of the enclosure with the inscriptions and the display window using a cloth moistened with water or a mild detergent.
- Do not use any aggressive cleansing agents or solvents, e.g. acetone. Plastic parts or the painted surface could be damaged. The inscriptions could become unreadable.

WARNING!

Electrostatic charge

Risk of explosion in hazardous areas if electrostatic charges develop, for example, when cleaning plastic surfaces with a dry cloth.

Prevent electrostatic charging in hazardous areas.

9.4. Maintenance and Repair Work

WARNING!

Impermissible repair of explosion protected devices

Risk of explosion in hazardous areas

Repair must be carried out by persons authorised by the manufacturer..



WARNING!

Maintenance during continued operation in a hazardous area

There is a risk of explosion when carrying out repairs and maintenance on the device in a hazardous area. Isolate the device from power.

- or -

Ensure that the atmosphere is explosion-free (hot work permit).

WARNING!

Impermissible accessories and spare parts

Risk of explosion in areas subject to explosion hazard.

Only use original accessories or original spare parts.

Observe all relevant installation and safety instructions described in the instructions for the device or enclosed with the accessory or spare part.

WARNING!

Humid environment

Risk of electric shock.

Avoid working on the device when it is energized.

If working on an energized device is necessary, ensure that the environment is dry.

Make sure when carrying out cleaning and maintenance work that no moisture penetrates the inside of the device.

CAUTION!

Hot parts in the device

Temperatures that can burn unprotected skin may be present for some time after the device has been switched off.

Observe the waiting time specified in "Technical Data" (chapter 11, page 157) before starting with maintenance work.

WARNING!

Enclosure open

Risk of explosion in hazardous areas as a result of hot components and/or charged capacitors inside the device.

To open the device in a hazardous area:

1. Isolate the device from power.
2. Observe the wait time specified in "Technical Data" (chapter 11, page 157) before opening the device.
3. Visually inspect sensor inlet and outlet.

Exception: Devices exclusively having the type of protection "Intrinsic safety Ex i" may be opened in an energized state in hazardous areas.



CAUTION!

Hazardous voltage at open device

Risk of electric shock when the enclosure is opened or enclosure parts are removed.

Before you open the enclosure or remove enclosure parts, de-energize the device.

If maintenance measures in an energized state are necessary, observe the particular precautionary measures. Have maintenance work carried out by qualified personnel.

WARNING!

Hot, toxic or corrosive process media

Risk of injury during maintenance work.

When working on the process connection, hot, toxic or corrosive process media could be released.

As long as the device is under pressure, do not loosen process connections and do not remove any parts that are pressurized.

Before opening or removing the device ensure that process media cannot be released.

WARNING!

Improper connection after maintenance

Risk of explosion in areas subject to explosion hazard.

Connect the device correctly after maintenance.

Close the device after maintenance work.

Refer to “Cables and Cable Entries” (chapter 11.6.2, page 163).

The device is maintenance-free. However, a periodic inspection according to pertinent directives and regulations must be carried out.

An inspection can include check of:

- Ambient conditions
 - Seal integrity of the process connections, cable entries, and cover screws
 - Reliability of power supply, lightning protection, and grounds
-

NOTE:

Repairs and service may only be carried out by persons authorised by the manufacturer.

The manufacturer defines flow sensors as non-repairable products.

Maintenance information parameters

The basic maintenance information parameters are:

- Current Date and Time
- Operating Time Total
- Operating Time
- Configuration Counter
- Transmitter Hardware Revision
- HMI Hardware Revision
- Sensor Hardware Revision



9.4.1. Service Information

Service information is information about the condition of the device used for diagnostics and service purposes.

Service information parameters

The basic service information parameters are:

- Driver Current
- Pickup 1 Amplitude
- Pickup 2 Amplitude
- Sensor Frequency
- Process Media Temperature
- Zero Point Adjustment Auto/Manual
- Zero Point Offset Value
- Manual Zero Point
- Zero Point Standard Deviation

9.5. Replacing the Device

If the equipment has been used for measuring corrosive substances there is a risk of chemical burns when disassembling.

CAUTION!

Corrosive substances

Risk of chemical burns when replacing the sensor.

The sensor in the device contains corrosive substances that result in burns on unprotected skin.

Make sure that the sensor housing is not damaged when replacing the sensor.

If contact with the corrosive substances occurs, rinse the affected skin immediately with large amount of water to dilute substance.

9.6. Return Procedure

Enclose the bill of lading, return document and decontamination certificate in a clear plastic pouch and attach it firmly to the outside of the packaging.

Please us the RMA process from one of these regional websites:

US/Canada related sales:

<http://aw-lake.com/return-authorization-form/>

Rest of the world:

<https://www.kem-kueppers.com/en/contact/returns-rma.html>



Required forms

- Delivery note
- Return goods delivery note with the following information:
 - Product (item description)
 - Number of returned devices/replacement parts
 - Reason for returning the item(s)
- Decontamination declaration
(<https://www.kem-kueppers.com/en/service/downloads/formulare.html>)

With this declaration you warrant "that the device/replacement part has been carefully cleaned and is free of residues. The device/replacement part does not pose a hazard for humans and the environment."

If the returned device/replacement part has come into contact with poisonous, corrosive, flammable or water-contaminating substances, you must thoroughly clean and decontaminate the device/replacement part before returning it in order to ensure that all hollow areas are free from hazardous substances. Check the item after it has been cleaned.

Any devices/replacement parts returned without a decontamination declaration will be cleaned at your expense before further processing.

9.7. Disposal



Devices described in this manual should be recycled. They may not be disposed of in the municipal waste disposal services according to the Directive 2012/19/EC on waste electronic and electrical equipment (WEEE).

Devices can be returned to the supplier within the EC, or to a locally approved disposal service for eco-friendly recycling. Observe the specific regulations valid in your country.

NOTE:

Special disposal required

The device includes components that require special disposal.

Dispose of the device properly and environmentally through a local waste disposal contractor.



10. Diagnosing and Troubleshooting

10.1. Device Status Symbols

Messages are shown in the display.

- In the operation view the alarms are shown as a combination of symbol and text in the lower line of the display. If several diagnostic messages are active at the same time, the most critical is shown.
- In the alarm list view all active alarms are shown as a list. The alarm list combines a symbol, text and an alarm ID number. The alarms are arranged according to the alarm ID numbers. The alarm list view can also be accessed via **Active diagnostic events**.
- In the alarm history view the most recent alarms (up to 100) are listed. The alarm history log can be viewed in **Diagnostic log**. The alarm history log can be reset in **Reset log**.

Characteristics of messages







The device provides two types of alarm formats, TRICOR standard alarm classes and NAMUR status signals, selected in **Status icons**.

The following tables summarize the two types of alarm formats in an overview.

The sequence of the symbols corresponds to the priority of the messages, beginning with the most critical.

TRICOR standard alarm classes

TRICOR standard alarm classes

Icon	Priority Level	Name	Description
	1	Maintenance failure	Maintenance alarm: maintenance demanded immediately Measurement values are not valid
	5	Maintenance warning	Maintenance warning Measured signal still valid
	6	Maintenance required	Maintenance required Measured signal still valid
	3	Process value alarm	Process value has reached an alarm limit
	4	Process value warning	Process value has reached a warning limit
	2	Function check	<ul style="list-style-type: none"> • Change of configuration, local operation, or substitute value entered Output signals are temporarily invalid

Tab. 30: TRICOR standard alarm classes



NAMUR status signals

Icon	Priority Level	Name	Description
	1	Failure	<ul style="list-style-type: none"> Failure Invalid output signal
	3	Out of specification	<ul style="list-style-type: none"> Out of specification Device will still work, but output signals may be invalid
	4	Maintenance required	<ul style="list-style-type: none"> Maintenance request Measured signal still valid
	2	Function check	<ul style="list-style-type: none"> Function check Output signal temporarily invalid

Tab. 31: NAMUR status signals

Info icons

Icon	Name	Description
	Read only	<ul style="list-style-type: none"> Write access disabled Indicate read only parameters
	Data exchange	Device is communicating
	Custody transfer enabled	N/A
	Memory card	Capacity is 25 % used
	Memory card	Capacity is 50 % used
	Memory card	Capacity is 75 % used
	Memory card	Capacity is 100 % used

Tab. 32: Info icons

The table explains the meaning of possible device status and actions for the user or service. The status messages are displayed as TRICOR and/or NAMUR NE107 symbols. Additionally status messages can be read and visualized with remote engineering, plant management or process control systems. Refer to the operating manual of your automation system.





















10.2. Fault Codes and Corrective Actions



















Alarms and system messages support both TRICOR standard alarm classes and NAMUR status signals.

In the following tables the alarm IDs (identification numbers) are listed along with possible causes and directions for corrective action.













10.2.1. Sensor Diagnostic Events

ID/ Icons	Diagnostic	Action	Comments
36  	Sensor supply volt. out of range	Contact your local TRICOR representative	
37  	Sensor supply volt. out of range	Contact your local TRICOR representative	
38  	Temperature measurement fault	Turn off the power, wait 5 seconds and turn on the power again. If the failure continues then contact your local TRICOR representative	
39  	Temperature measurement fault	Turn off the power, wait 5 seconds and turn on the power again. If the failure continues then contact your local TRICOR representative	
40  	Temperature measurement fault	Turn off the power, wait 5 seconds and turn on the power again. If the failure continues then contact your local TRICOR representative	
41  	Temperature measurement fault	Turn off the power, wait 5 seconds and turn on the power again. If the failure continues then contact your local TRICOR representative	
42  	Flow values not valid	Can be due to problems with measured fluid or hardware malfunction. If the failure continues then contact your local TRICOR representative	
43  	Flow values not valid	Can be due to problems with measured fluid or hardware malfunction. If the failure continues then contact your local TRICOR representative	
44  	Flow values not valid	Can be due to problems with measured fluid or hardware malfunction. If the failure continues then contact your local TRICOR representative	













ID/ Icons	Diagnostic	Action	Comments
45 	Flow values not valid	Can be due to problems with measured fluid or hardware malfunction. If the failure continues then contact your local TRICOR representative	
46  	Invalid calibration data	Contact your local TRICOR representative for recalibration	
47  	Invalid compensation data	Contact your local TRICOR representative	
49  	Malfunction in pickup amplitude	Contact your local TRICOR representative	
50  	Malfunction in pickup amplitude	Contact your local TRICOR representative	
51  	Malfunction in pickup amplitude	Contact your local TRICOR representative	
55  	Malfunction in sensor driver	Contact your local TRICOR representative	
56  	Malfunction in sensor driver	Contact your local TRICOR representative	
57  	Malfunction in sensor driver	Contact your local TRICOR representative	
58  	Unstable driver oscillation	Contact your local TRICOR representative	
59  	Massflow out of specification	Reduce the flow. If the failure continues then contact your local TRICOR representative	
60  	Volume flow out of specification	Reduce the flow. If the failure continues then contact your local TRICOR representative	
61  	Density out of specification	Contact your local TRICOR representative	



ID/ Icons	Diagnostic	Action	Comments
62 	Fluid temp. below limit	Increase the fluid temperature. If the failure continues then contact your local TRICOR representative	
63 	Fluid temp. above limit	Reduce the fluid temperature. If the failure continues then contact your local TRICOR representative	
66 	Standard deviation' above limit	Measurement continues with values from last successful zero point adjustment. Improve conditions for automatic zero point adjustment and repeat adjustment.	
67 	Zero point offset' above limit	Measurement continues with values from last successful zero point adjustment. Improve conditions for automatic zero point adjustment and repeat adjustment.	
68 	Zero point adjustment failed	Measurement continues with values from last successful zero point adjustment. Improve conditions for automatic zero point adjustment and repeat adjustment.	
69 	Empty tube limit' exceeded	Make sure that the sensor is filled with liquid and that the liquid density is within the specified 'Empty Tube Limit'	
70 	Too little fluid in tube	Make sure that the sensor is filled with liquid	
71 	Parameter storage malfunction	Turn off the power, wait 5 seconds and turn on the power again. If the failure continues then contact your local TRICOR representative	
72 	Internal error in sensor	Contact your local TRICOR representative	
73 	Internal error in sensor	Contact your local TRICOR representative	
74 	Internal error in sensor	Contact your local TRICOR representative	
75 	Internal error in sensor	Contact your local TRICOR representative	



ID/ Icons	Diagnostic	Action	Comments
76  	Internal error in sensor	Contact your local TRICOR representative	
77  	Internal error in sensor	Contact your local TRICOR representative	
78  	Unstable measurement condition	Check if air is present in the liquid and that the flow meter is operated within its specifications.	
79  	Auto filtering	Check that the flow meter is operated within its specifications. Check other alarms to rule out HW malfunction.	
87  	The sensor is stabilizing	Check sensor cable connection. Wait 20 seconds. If the status remains 'Coming' then turn off the power, wait 5 seconds and turn on the power again. If the failure continues then contact your local TRICOR representative	

























Tab. 33: Sensor diagnostic events



























10.2.2. Transmitter Diagnostic Events

ID/ Icons	Diagnostic	Action	Comments
96 	Mass flow	Value above alarm limit. Check process conditions or align limit to normal operation. Adjust parameter 'Upper alarm limit'.	
97 	Mass flow	Value above warning limit. Check process conditions or align limit to normal operation. Adjust parameter 'Upper warning limit'.	
98 	Mass flow	Value below warning limit. Check process conditions or align limit to normal operation. Adjust parameter 'Lower warning limit'.	
99 	Mass flow	Value below alarm limit. Check process conditions or align limit to normal operation. Adjust parameter 'Lower alarm limit'.	
100 	Volume flow	Value above alarm limit. Check process conditions or align limit to normal operation. Adjust parameter 'Upper alarm limit'.	
101 	Volume flow	Value above warning limit. Check process conditions or align limit to normal operation. Adjust parameter 'Upper warning limit'.	
102 	Volume flow	Value below warning limit. Check process conditions or align limit to normal operation. Adjust parameter 'Lower warning limit'.	
103 	Volume flow	Value below alarm limit. Check process conditions or align limit to normal operation. Adjust parameter 'Lower alarm limit'.	
104 	Density	Value above alarm limit. Check process conditions or align limit to normal operation. Adjust parameter 'Upper alarm limit'.	
105 	Density	Value above warning limit. Check process conditions or align limit to normal operation. Adjust parameter 'Upper warning limit'.	

























ID/ Icons	Diagnostic	Action	Comments
106  	Density	Value below warning limit. Check process conditions or align limit to normal operation. Adjust parameter 'Lower warning limit'	
107  	Density	Value below alarm limit. Check process conditions or align limit to normal operation. Adjust parameter 'Lower alarm limit'	
108  	Medium temperature	Value above alarm limit. Check process conditions or align limit to normal operation. Adjust parameter 'Upper alarm limit'	
109  	Medium temperature	Value above warning limit. Check process conditions or align limit to normal operation. Adjust parameter 'Upper warning limit'	
110  	Medium temperature	Value below warning limit. Check process conditions or align limit to normal operation. Adjust parameter 'Lower warning limit'	
111  	Medium temperature	Value below alarm limit. Check process conditions or align limit to normal operation. Adjust parameter 'Lower alarm limit'	
112  	Fraction A %	Value above alarm limit. Check process conditions. Align Upper alarm limit to normal process conditions.	
113  	Fraction A %	Value above warning limit. Check process conditions. Align Upper warning limit to normal process conditions	
114  	Fraction A %	Value below warning limit. Check process conditions. Align Lower warning limit to normal process conditions.	
115  	Fraction A %	Value below alarm limit. Check process conditions. Align Lower alarm limit to normal process conditions.	
116  	Fraction B %	Value above alarm limit. Check process conditions. Align Upper alarm limit to normal process conditions.	
117  	Fraction B %	Value above warning limit. Check process conditions. Align Upper warning limit to normal process conditions	





















ID/ Icons	Diagnostic	Action	Comments
118  	Fraction B %	Value below warning limit. Check process conditions. Align Lower warning limit to normal process conditions.	
119  	Fraction B %	Value below alarm limit. Check process conditions. Align Lower alarm limit to normal process conditions.	
120  	Fraction A flow	Value above alarm limit. Check process conditions. Align Upper alarm limit to normal process conditions.	
121  	Fraction A flow	Value above warning limit. Check process conditions. Align Upper warning limit to normal process conditions	
122  	Fraction A flow	Value below warning limit. Check process conditions. Align Lower warning limit to normal process conditions.	
123  	Fraction A flow	Value below alarm limit. Check process conditions. Align Lower alarm limit to normal process conditions.	
124  	Fraction B flow	Value above alarm limit. Check process conditions. Align Upper alarm limit to normal process conditions.	
125  	Fraction B flow	Value above warning limit. Check process conditions. Align Upper warning limit to normal process conditions	
126  	Fraction B flow	Value below warning limit. Check process conditions. Align Lower warning limit to normal process conditions.	
127  	Fraction B flow	Value below alarm limit. Check process conditions. Align Lower alarm limit to normal process conditions.	
128  	Standard density	Value above alarm limit. Check process conditions. Align Upper alarm limit to normal process conditions.	
129  	Standard density	Value above warning limit. Check process conditions. Align Upper warning limit to normal process conditions	
130  	Standard density	Value below warning limit. Check process conditions. Align Lower warning limit to normal process conditions.	



ID/ Icons	Diagnostic	Action	Comments
131  	Standard density	Value below alarm limit. Check process conditions. Align Lower alarm limit to normal process conditions.	
132  	Standard volume flow	Value above alarm limit. Check process conditions or align limit to normal operation. Adjust parameter 'Upper alarm limit'	Only hydrocarbon
133  	Standard volume flow	Value above warning limit. Check process conditions or align limit to normal operation. Adjust parameter 'Upper warning limit'	Only hydrocarbon
134  	Standard volume flow	Value below warning limit. Check process conditions or align limit to normal operation. Adjust parameter 'Lower warning limit'	Only hydrocarbon
135  	Standard volume flow	Value below alarm limit. Check process conditions or align limit to normal operation. Adjust parameter 'Lower alarm limit'	Only hydrocarbon
136  	Totalizer 1	Value above alarm limit. Check process conditions or align limit to normal operation. Adjust parameter 'Upper alarm limit'	
137  	Totalizer 1	Value above warning limit. Check process conditions or align limit to normal operation. Adjust parameter 'Upper warning limit'	
138  	Totalizer 1	Value below warning limit. Check process conditions or align limit to normal operation. Adjust parameter 'Lower warning limit'	
139  	Totalizer 1	Value below alarm limit. Check process conditions or align limit to normal operation. Adjust parameter 'Lower alarm limit'	
140  	Totalizer 2	Value above alarm limit. Check process conditions or align limit to normal operation. Adjust parameter 'Upper alarm limit'	
141  	Totalizer 2	Value above warning limit. Check process conditions or align limit to normal operation. Adjust parameter 'Upper warning limit'	













ID/ Icons	Diagnostic	Action	Comments
142  	Totalizer 2	Value below warning limit. Check process conditions or align limit to normal operation. Adjust parameter 'Lower warning limit'	
143  	Totalizer 2	Value below alarm limit. Check process conditions or align limit to normal operation. Adjust parameter 'Lower alarm limit'	
144  	Totalizer 3	Value above alarm limit. Check process conditions or align limit to normal operation. Adjust parameter 'Upper alarm limit'	
145  	Totalizer 3	Value above warning limit. Check process conditions or align limit to normal operation. Adjust parameter 'Upper warning limit'	
146  	Totalizer 3	Value below warning limit. Check process conditions or align limit to normal operation. Adjust parameter 'Lower warning limit'	
147  	Totalizer 3	Value below alarm limit. Check process conditions or align limit to normal operation. Adjust parameter 'Lower alarm limit'	
148  	Transmitter temperature	Transmitter temperature above alarm limit. Relocate the device if possible or lower the ambient temperature enough to cool the device. Inspect the device for heat-related damage.	
149  	Transmitter temperature	Transmitter temperature below alarm limit. Relocate the device if possible or raise the ambient temperature enough to heat the device. Inspect the device for cold-related damage.	
150 	Sensor signal disrupted	Turn off the power. Unplug and reconnect the sensor cable. Restore power. If the error still exists, contact your local TRICOR representative.	
151  	SD-Card	Backup disabled. Another SD-Card was inserted. To acknowledge please copy the configuration from the SD-Card to the device, remove this SD-Card and insert the original SD-Card.	

























ID/ Icons	Diagnostic	Action	Comments
152 	SD-Card	Backup disabled. Another SD-Card was inserted. To acknowledge please copy the configuration from the SD-Card to the device, remove this SD-Card and insert the original SD-Card.	
153 	CH1	Loop current in lower sat.. Check process conditions or Align Lower range value'	
154 	CH1	Loop current in upper sat.. Check process conditions or adjust channel parameter "Upper range value"	
155 	CH1	Loop current deviation. Check current output cable connection. In passive mode check power supply.	
158 	HART	Cable break. Check current output cable connection	
159 	Internal error	Internal error in transmitter. Turn off the power, wait 5 seconds and turn on the power again. If the error still exists, contact your local TRICOR representative.	
160 	Mass flow	Value simulated. Disable 'Simulation' before returning to normal operation	
161 	Volume flow	Value simulated. Disable 'Simulation' before returning to normal operation	
162 	Density	Value simulated. Disable 'Simulation' before returning to normal operation	
163 	Medium temperature	Value simulated. Disable 'Simulation' before returning to normal operation	
166 	Standard volume flow	Value simulated. Disable 'Simulation' before returning to normal operation	Only hydrocarbon
167 	Totalizer 1	Value simulated. Disable 'Simulation' before returning to normal operation	













ID/ Icons	Diagnostic	Action	Comments
168 	Totalizer 2	Value simulated. Disable 'Simulation' before returning to normal operation	
169 	Totalizer 3	Value simulated. Disable 'Simulation' before returning to normal operation	
170 	Loop current	Loop current simulated. Disable 'Simulation' before returning to normal operation	Only HART devices
172 	Transmitter	FW invalid. A component does not have the expected FW version. Start a product firmware update to update the component version or replace the component.	
173 	Sensor	FW invalid. A component does not have the expected FW version. Start a product firmware update to update the component version or replace the component.	
174 	Display	FW of the I/O-Module invalid. A component does not have the expected FW version. Start a product firmware update to update the component version or replace the component.	
175 	IO	FW invalid. A component does not have the expected FW version. Start a product firmware update to update the component version or replace the component.	
176 	Sensor	Sensor type incompatible. Please replace sensor.	
177 	Device is starting	Please wait until startup is finished. Startup time see manual.	
178 	Transmitter	FW invalid. A component does not have the expected FW version. Start a product firmware update to update the component version.	



ID/ Icons	Diagnostic	Action	Comments
179  	Alarm class	Alarm class simulated. Disable Simulation before returning to normal operation.	No detailed information available in view Active diagnostic events. Icon depends on simulated alarm class resp. NAMUR status signal and the priority in case of multiple alarm classes simulated.
181  	SD-Card	SD-Card Chkdsk failed. Start Chkdsk again. If error still exist replace SD-Card.	
182  	Communication Interface	FW invalid. A component does not have the expected FW version. Start a product firmware update to update the component version or replace the component.	
183  	CH2	Input current too low. Check wiring and signal of connected sensor or output source to input channel.	If Operation mode is configured to Current input.
184  	CH2	Input current too high. Check wiring and signal of connected sensor or output source to input channel.	If Operation mode is configured to Current input
185  	CH2	External failure. Connected sensor or output to input channel is out of operation range. Please check connected sensor or output source.	If Operation mode is configured to Current input
186  	CH3	Input current too low. Check wiring and signal of connected sensor or output source to input channel.	If Operation mode is configured to Current input
187  	CH3	Input current too high. Check wiring and signal of connected sensor or output source to input channel.	If Operation mode is configured to Current input
188  	CH3	External failure. Connected sensor or output to input channel is out of operation range. Please check connected sensor or output source.	If Operation mode is configured to Current input
189  	CH4	Input current too low. Check wiring and signal of connected sensor or output source to input channel.	If Operation mode is configured to Current input
190  	CH4	Input current too high. Check wiring and signal of connected sensor or output source to input channel.	If Operation mode is configured to Current input



Diagnosing and Troubleshooting

ID/ Icons	Diagnostic	Action	Comments
191 	CH4	External failure. Connected sensor or output to input channel is out of operation range. Please check connected sensor or output source.	If Operation mode is configured to Current input
192 	Dosing	Dosing time overrun. Check installation. If ok, increase 'Duration Time'.	
193 	Dosing	Dosing quantity overrun. Check installation. If ok, decrease 'Overrun Value'.	
194 	Dosing	Invalid process value during dosing. Check installation for abnormal operating conditions. If the error still exists, contact your local TRICOR representative.	
195 	CH2	Loop current in lower saturation. Check process conditions or align limit to normal operation. Adjust channel 2 parameter 'Lower range value'.	If Operation mode is configured to Current output
196 	CH2	Loop current in upper saturation. Check process conditions or align limit to normal operation. Adjust channel 2 parameter 'Upper range value'.	If Operation mode is configured to Current output
197 	CH2	Cable break. Check channel 2 current output cable connection.	If Operation mode is configured to Current output
198 	CH2	Frequency too low. Check process conditions or align limit to normal operation. Adjust channel 2 parameter 'Lower range value'.	If Operation mode is configured to Frequency output
199 	CH2	Frequency too high. Check process conditions or align limit to normal operation. Adjust channel 2 parameter 'Upper range value'.	If Operation mode is configured to Frequency output
200 	CH2	Pulse overflow. Pulse output insufficient pulse separation. Reduce pulses per amount, or reduce pulse width, or increase amount.	If Operation mode is configured to Pulse output
201 	CH3	Loop current in lower saturation. Check process conditions or align limit to normal operation. Adjust channel 3 parameter 'Lower range value'.	If Operation mode is configured to Current output





ID/ Icons	Diagnostic	Action	Comments
202 	CH3	Loop current in upper saturation. Check process conditions or align limit to normal operation. Adjust channel 3 parameter 'Upper range value'.	If Operation mode is configured to Current output
203 	CH3	Cable break. Check channel 3 current output cable connection.	If Operation mode is configured to Current output
204 	CH3	Frequency too low. Check process conditions or align limit to normal operation. Adjust channel 3 parameter 'Lower range value'.	If Operation mode is configured to Frequency output
205 	CH3	Frequency too high. Check process conditions or align limit to normal operation. Adjust channel 3 parameter 'Upper range value'.	If Operation mode is configured to Frequency output
206 	CH3	Pulse overflow. Pulse output insufficient pulse separation. Reduce pulses per amount, or reduce pulse width, or increase amount.	If Operation mode is configured to Pulse output
207 	CH4	Loop current in lower saturation. Check process conditions or align limit to normal operation. Adjust channel 4 parameter 'Lower range value'.	If Operation mode is configured to Current output
208 	CH4	Loop current in upper saturation. Check process conditions or align limit to normal operation. Adjust channel 4 parameter 'Upper range value'.	If Operation mode is configured to Current output
209 	CH4	Cable break. Check channel 4 current output cable connection.	If Operation mode is configured to Current output
210 	CH4	Frequency too low. Check process conditions or align limit to normal operation. Adjust channel 4 parameter 'Lower range value'.	If Operation mode is configured to Frequency output
211 	CH4	Frequency too high. Check process conditions or align limit to normal operation. Adjust channel 4 parameter 'Upper range value'.	If Operation mode is configured to Frequency output
212 	CH4	Pulse overflow. Pulse output insufficient pulse separation. Reduce pulses per amount, or reduce pulse width, or increase amount.	If Operation mode is configured to Pulse output



Diagnosing and Troubleshooting

ID/ Icons	Diagnostic	Action	Comments
214 	CH2	Channel simulated. Disable 'Simulation' before returning to normal operation.	
215 	CH3	Channel simulated. Disable 'Simulation' before returning to normal operation.	
216 	CH4	Channel simulated. Disable 'Simulation' before returning to normal operation.	
217 	Process Values Frozen	All process values and totalizers are frozen. To return to normal operation the related input signal has to switch.	
218 	Outputs Forced	Outputs are forced. To return to normal operation the related input signal has to switch.	
219 	CH2	Loop current deviation. Check current output cable connection. In passive mode check power supply.	If Operation mode is configured to Current output
220 	CH3	Loop current deviation. Check current output cable connection. In passive mode check power supply.	If Operation mode is configured to Current output
221 	CH4	Loop current deviation. Check current output cable connection. In passive mode check power supply.	If Operation mode is configured to Current output
222 	Modbus	Invalid register mapping. Source register allocated in duplicate. Check register mapping.	
223 	Modbus	Invalid coil configuration. Modbus coils are not configured correctly. Check coil allocation.	
285 	Datalogging	DATALOGGING 30 DAYS LEFT	
286 	Datalogging	DATALOGGING 7 DAYS LEFT	
287 	Datalogging	DATALOGGING SDCARD FULL	



ID/ Icons	Diagnostic	Action	Comments
288 	Frame Temperature Simulated	Value simulated. Disable 'Simulation' to return to normal operation.	
298 	Standard Volume Flow Simulated	Value simulated. Disable 'Simulation' to return to normal operation.	

Tab. 34: Transmitter diagnostic events



10.3. Operation Troubleshooting

10.3.1. How do I copy application setup from one device to another?

1. Remove the SD-Card from the source device and insert the SD-Card into the destination device. The destination device disables the backup and signals an alarm.
2. Enter menu item 3.3.1 Copy configuration, select "OK" and press  to execute the copying and move all the application setup parameters from the SD-Card to the device. Backup is still disabled and alarm signaled.
3. Remove the SD-Card from the destination device and insert the original SD-Card. The device synchronizes the parameters to the SD-Card and the alarm is cleared.

10.3.2. Troubleshooting Sensor-related Problems

Incorrect and unstable measurements, especially at low flows, are typically a result of an unstable zero point due to:

- Incorrect installation
- Bubbles in the liquid
- Vibrations/Cross talk
- Solid particles settling in the liquid

In the following a 4-step guide to troubleshooting is provided:

- | | |
|--------|------------------------------------|
| Step 1 | Preliminary application inspection |
| Step 2 | Zero point adjustment |
| Step 3 | Measurement error calculation |
| Step 4 | Application improvement |

The guide will enable you to trace the reason for incorrect measurements and to improve the application.

Step 1: Inspecting the application

Ensure that:

1. The sensor is installed as described in "Installing/Mounting" (chapter 4, page 27).
2. The sensor is located in a vibration-free position. System vibrations can disturb the sensor and cause measurement errors.

Depending on application, you should furthermore ensure the following:

- Liquid application
Ensure that the sensor is filled with liquid and liquid only.
Gas bubbles in the liquid can lead to measurement errors (unstable measurement signals, measurement errors of the process parameters).
Flush the pipe systems and the sensor for several minutes at high flowrate to remove any gas bubbles which may be present.



NOTE:

The liquid must be homogeneous in order to measure with high accuracy. If the liquid contains solid particles of greater density than the liquid, then these solids can settle, especially at low flow rates. This can lead to measurement errors in density and flow rate.

For pastes or process fluids with suspended solids always orient the sensor vertically with flow in upward direction to maintain solids suspension.

- Gas application
Ensure that the gas pressure/temperature conditions are suitably selected to prevent dew formation or precipitation in the measuring tubes. If the gas contains vapor or droplets, they may precipitate and cause unstable measurement signals and errors.

Step 2: Performing a zero point adjustment

The second step in the troubleshooting procedure is to zero point adjust the device. For further information on zero point adjustment, see “Commissioning” (chapter 6, page 63).

Step 3: Calculating the measurement error

The result of the zero point adjustment will show you if the zero point was set under good and stable conditions.

The lower the obtained value of the parameter **Zero Point Standard Deviation**, the lower is the achievable measuring error. For a well-installed flow meter, the Zero Point Standard Deviation corresponds to the specified zero point stability for the sensor size, see “Performance” (chapter 11.2, page 158).

Calculating the measurement error

The error curve is plotted from the formula:

$$E = \sqrt{(Cal)^2 + \left(\frac{Z * 100}{qm}\right)^2}$$

- E = Error [%]
- Z = Zero point [kg/h]
- qm = Mass flow [kg/h]
- Cal. = Calibrated flow accuracy: 0.10

Error in % of actual mass flow rate with 95 % confidence (probability)

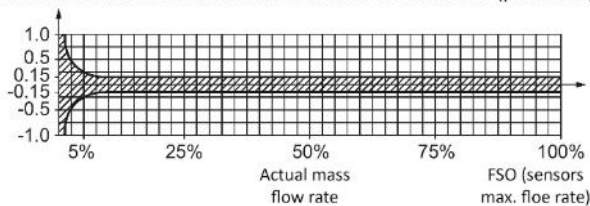

Fig. 94: example measurement error



Flow Conditions	Fully Developed Flow Profile
Temperature Medium	20 °C ± 2 °C [68 °F ± 35.6 °F]
Temperature Ambient	20 °C ± 2 °C [68 °F ± 35.6 °F]
Liquid Pressure	2 ± 1 bar
Density	0.997 g/cm ³
Brix	40 °Brix
Supply Voltage	Un ± 1 %
Warming-up Time	30 min.
Cable Length	6 m between transmitter and sensor

Tab. 35: Reference conditions for flow calibrations (ISO 9104 and DIN/EN 29104)

Current Output	As pulse output ± (0.1% of actual flow +0.05 % FSO)
Effect of Ambient Temperature	Display/frequency/pulse output: < ± 0.003%/K act. ± 3.6 °F) Current output: < ± 0.005 %/ K act.
Effect of Supply Voltage	< 0.005 % of measuring value on 1 % alteration

Tab. 36: Additions in the event of deviations from reference conditions

Step 4: Improving the application

In the following it is described how to find the causes of a high Zero Point Standard Deviation and how to improve the installation.

Setting Low Flow Cut-Off

In order to see if the zero point becomes more stable when making changes/adjustments, the Low Mass Flow Cut-Off (MassFlowCutOff) must be set to 0.0 kg/s.

When Low Flow Cut-Off has been set, it is possible to see the instability directly from the massflow in the online window ("View" → "Process variables")

This information can be used to troubleshoot. For example, tightening the brackets which hold the sensor, or turning off the pump to check if vibrations from the pump are disturbing the sensor, etc.

Incorrect installation of the sensor

Has the sensor been correctly installed, that is fastened to the floor/wall or frame with good mounting brackets as shown in the instructions?

Especially for low flowrates, that is flowrates less than 10% of the maximum capacity of the flow meter, it is important that the sensor is correctly and stably installed.

If the sensor is not correctly fixed in place, the zero point of the sensor will change, leading to measuring errors.

Try to tighten up the sensor brackets to see whether the flow instability is reduced.



Vibrations and cross talk

Vibrations in the pipe system are normally generated by pumps.

Typically, cross talk is generated by two sensors of identical size and positioned in close proximity in the same pipe, or installed on the same rail or frame.

Vibrations/cross talk have a greater or lesser effect upon the zero point stability and therefore also the measurement accuracy.

1. Check whether there are vibrations.

Turn off the pump and check whether the zero point stability improves, that is if the mass/volume flow fluctuation is reduced.

If the sensor is disturbed by vibration from the pump or by pressure pulsations, the installation should be improved or the pump should be exchanged, for example to another type.

2. Check for cross talk.

Turn off the power to the other flow meter(s) and wait approximately 2 minutes, so the measuring tubes in the sensor have stopped vibrating. Then check if the zero point stability has improved, that is that the mass/volume flow fluctuation has been reduced. If this is the case, the sensors disturb one another and the installation should be improved.

Air in the liquid

When air is present in the liquid, the zero point becomes unstable, which leads to a poor measurement accuracy.

Checking for air:

- Check the Driver Current (View → Device Diagnostics → Advanced Diagnostic).
- Check if the Driver Current varies more than 6 mA. If this is the case, it is usually due to the presence of air or gas bubbles in the liquid.
- Increase the pressure in the sensor, creating a large back pressure upon the sensor by reducing the opening of the outlet valve or by increasing the pump pressure. Thereby the size of air bubbles inside the sensor will be minimized. If the Driver Current value increases and/or the stability of the Driver Current decreases, it is proof that the liquid contains gas bubbles.

Typical causes of air in the liquid

- The entry pipe and sensor have not been properly filled with liquid.
- The pump cavitates, the rotary speed of the pump is too high in relation to the supply of liquid to the pump.
- The flow rate in the pipe is too high, so components sitting in front of the flow meter can cause cavitation.
- If there is a filter installed before the flow meter, it may be close to blocking, which also can cause cavitation.
- Liquid flashes to vapor bubbles while passing through partially open valves or orifices.
- The piping on the pump suction side, pump gaskets or the pump itself is not tight. Air gets sucked into the system due to a low pressure on the pump suction side.
- The piping on the pump suction side, pump gaskets or the pump itself is not tight. Air gets sucked into the system due to a low pressure on the pump suction side.



Solid particles in the liquid

If the solid particles in a liquid have a density higher than that of the liquid, they can precipitate inside the sensor and cause instability which leads to a measurement error.

If solid particles are present in the liquid, they must be homogeneously distributed and have similar density as the liquid. Otherwise they can cause measurement errors.

It is important that the sensor is installed such that solid particles can easily run out of the sensor.

1. Ensure that the sensor is installed vertically with an upwards flow.
2. Check if solid particles are present in the liquid:
Take a sample of the liquid, fill a glass and see if the solids precipitate.

10.3.3. How do I update the firmware?

Download the new firmware bundle from (www.tricorflow.com) and save it to the SD-Card. An instruction is also available at this site.

Access the flow meter with access level Expert (the default PIN code is 2208 (2834 for meters shipped before 01.11.2018)).

Enter menu item 3.1.2 (FW Update), select the saved firmware bundle version and press . The firmware update progress is shown in the display.

NOTE:

Firmware update

FW update is to be done only by authorized and trained service personnel.



11. Technical Data

NOTE:

Device specifications

TRICOR makes every attempt to ensure the accuracy of these specifications but reserves the right to change them at any time.

11.1. Power

Description	Specification
Supply Voltage	<ul style="list-style-type: none"> • 100 to 240 V AC, 47 to 63 Hz 15 VA • 19.2 - 28.8 V DC 7.5 W
Environmental Conditions:	<ul style="list-style-type: none"> • Transient over voltages up to the levels of overvoltage category II • Temporary over voltages occurring on mains supply only • POLLUTION DEGREE 2 • MAINS AC supply voltage fluctuations up to $\pm 10\%$ of the nominal voltage • Altitude up to 2,000 m
Reverse Polarity Protection (y/n)	On request
Galvanic Isolation	1,500 V AC

Tab. 37: Power supply



11.2. Performance

	TCMQ 6400	TCMQ 018K	TCMQ 070K
Max. Flow Rate (kg/h)	6,400	17,700	70,700
Max. Flow Rate (lb/min)	235	650	2,600
Basic Accuracy (Mass Flow)	±0.1 % of flow rate		
Basic Accuracy (Volume Flow)	±0.5 % (option: up to ±0.1 %) of flow rate		
Repeatability	±0.05 % of flow rate		
Zero Stability	±0.003 % of full scale	±0.01 % of full scale	
Density Range	up to 5,000 kg/m ³ [5.0 g/cm ³]		
Density Accuracy	±5.0 kg/m ³ (option: ±0.5 kg/m ³) [±0.005 g/cm ³ (option: ±0.0005 g/cm ³)]		
Density Repeatability	±0.25 kg/m ³ [±0.00025 g/cm ³]		
Measuring Accuracy Brix	0.1 °Brix (1,000 kg/m ³)		
Process Temperature Range	-60 °C ... +200 °C [-76 °F ... +392 °F]		
Temperature Repeatability	±0.5 °C ±0.25 % of reading [±0.9 °F ±0.25 % of reading]		

Tab. 38: Performance TCMQ

11.3. Interface

11.3.1. Modbus Interface

Description	Specification
Protocol Version	Modbus RTU
Default Transmission Rate	19,200 bit/s (default), selectable
Default Parity	Even (default), selectable
Default Device Address	1 (default), selectable

Tab. 39: Modbus communication

The description of the Modbus interface can be found in the Modbus manual.



11.3.2. HART Interface

Description	Specification
HART Revision	7.5

Tab. 40: HART communication

PROFIBUS interface

Description	Specification
Profile Version	V4.0 - compatible with version 3
Default Transmission Rate	Automatic baud rate detection

Tab. 41: HART communication

11.4. Inputs

Description	Channels 3 to 4
Load	15 to 30 V DC, Rin 7 k Ω
Functionality	<ul style="list-style-type: none"> Start/stop/hold/continue dosing Reset totalizer 1, 2 or 3 Reset all totalizers Freeze output

Tab. 42: Digital input

11.5. Outputs

Description	Channel 1	
Signal Range	4 to 20 mA	
Resolution	0.4 μA	
Load	<ul style="list-style-type: none"> Ex i: <470 Ω (HART ≥ 230 Ω) Non-Ex: <770 Ω (HART ≥ 230 Ω) 	
Time Constant (adjustable)	0.0 to 100 s	
Fault Current	4 - 20 NAMUR	4 - 20 US
Measurement Range (mA)	3.8 - 20.5	4.0 - 20.8
Lower Fault Current (mA)	3.5	3.75
Upper Fault Current (mA)	22.6	22.6
Customized Fail-safe Mode	<ul style="list-style-type: none"> Last reliable value Lower fault current Upper fault current Fail-safe value Current value 	
Galvanic Isolation	All inputs and outputs are galvanically isolated PELV circuits with	



Description	Channel 1
	60 V DC isolation from each other and ground. Maximum test voltage: 500 V AC
Cable	Standard industrial signal cable with up to 3 twisted pairs with overall screen can be connected between the transmitter and the control system. Individual pair or overall screen is optional depending on user requirements.
Voltage Range	Max. 24 V DC (active) 14 to 30 V DC (passive)

Tab. 43: Current output (Channel 1)

Description	Channels 2 to 4			
Signal Range	0/4 to 20 mA			
Resolution	0.4 μ A			
Load	<ul style="list-style-type: none"> • Ex i: <470 Ω • Non-Ex: <770 Ω 			
Time Constant (adjustable)	<ul style="list-style-type: none"> • 0.0 to 100 s 			
Fault Current	4-20 NAMUR	4-20 US	4-20 NAMUR	4-20 US
Measurement Range (mA)	3.8 - 20.5	4.0 - 20.8	4.0 - 20.5	4.0 - 24.0
Lower Fault Current (mA)	3.5	3.75	2.0	2.0
Upper Fault Current (mA)	22.6	22.6	22.0	25.0
Customized Fail-safe Mode	<ul style="list-style-type: none"> • Last reliable value <ul style="list-style-type: none"> - Lower fault current - Upper fault current • Fail-safe value • Current value 			
Galvanic Isolation	All inputs and outputs are galvanically isolated PELV circuits with 60 V DC isolation from each other and ground. Maximum test voltage: 500 V AC			
Cable	Standard industrial signal cable with up to 3 twisted pairs with overall screen can be connected between the transmitter and the control system. Individual pair or overall screen is optional depending on user requirements.			
Voltage Range	Max. 24 V DC (active) 14 to 30 V DC (passive)			

Tab. 44: Current output (Channels 2 to 4)



Description	Channels 2 to 4
Pulse	41.6 μ s to 5 s pulse duration
Resolution	1 μ s
Frequency	0 to 12.5 kHz, 50 % duty cycle, 120 % overscale provision
Resolution	0.2 Hz
Load	< 750 Ω
Time Constant (adjustable)	0 to 100 s
Active	0 to 24 V DC, 87 mA, short-circuit-protected
Passive	3 to 30 V DC, 100 mA, short-circuit-protected
Functions	<ul style="list-style-type: none"> • Pulse • Frequency • Alarm class/NAMUR status • Individual alarms

Tab. 45: Digital output

Description	Channels 3 to 4
Type	Change-over voltage-free relay contact
Load	30 V AC, 100 mA
Functions	<ul style="list-style-type: none"> • Alarm class/NAMUR status • Individual alarms

Tab. 46: Relay output

11.6. Construction

Description	Specification
Measurement of Process Medium	<ul style="list-style-type: none"> • Fluid Group 1 (suitable for dangerous fluids) • Aggregate state: paste/light slurry, liquid and gas

Tab. 47: Designated use

Description	Specification
Measuring Principle	Coriolis
System Architecture	Compact configuration Remote configuration

Tab. 48: Construction



Device design

Description	Specification
Dimensions	See “Transmitter Dimensions” (chapter 11.14, page 175)
Design	Compact or remote
Material	Aluminum with corrosion-resistant coating
Ingress Protection	IP65, Optional: IP67/NEMA 4X to EN/IEC 60529 (1 mH ₂ O for 30 min.)
Mechanical Load	18 to 1,000 Hz random, 3.17 g RMS, in all directions, to IEC 68-2-36

Tab. 49: Transmitter design

NOTE:

NPT glands

When using NPT glands, the user must take care to use the supplied NPT thread adaptors.

11.6.1. Sensor Design

	TCMQ 6400	TCMQ 018K	TCMQ 070K
Process and Ambient			
Process Connections	DN15 – EN 1092-1 B1, PN40	DN25 – EN 1092-1 B1, PN40	DN50 – EN 1092-1 B1, PN16
Max. Pressure Standard (process connection dependent)	100 bar [1,450 psi]		
Pressure Drop at max. Flow	For detail information please contact us		
General			
Tube Arrangement	parallel	parallel	parallel
Tube Inner Diameter	8 mm [0.31 in]	14 mm [0.55 in]	28 mm [1.1 in]
Design	Fully welded		
Tube Material	1.4435 [AISI 316L]		
Housing Material	1.4301 [AISI 304]		
Wetted Material	1.4404 [AISI 316L]		
Dimensions	See “Sensor Dimensions” (chapter 11.13, page 175)		
Electrical Connection	<ul style="list-style-type: none"> • M12 connector with 4-wire cable • Standard cable with polymer/brass/ • stainless steel cable glands (NPT) • Armored cable with stainless steel armored cable glands (NPT) • Conduit entries (NPT) 		
Transmitter Enclosure	Aluminum with corrosion-resistant coating		

Tab. 50: Sensor design



11.6.2. Cables and Cable Entries

Description	Specification
Number of Conductors	4
Square Area	0.326 mm ² (AWG 22/7)
Screen	Yes
Outside Color	<ul style="list-style-type: none"> • Standard version: gray (RAL 7001) • Ex version: light-blue (RAL 5015)
Description	Specification
Permissible Temperature Range	-40 °C ... +80 °C [-40 °F ... +176 °F]
Min. Bending Radius Allowed	Single 5 x \varnothing

Tab. 51: Sensor cable, basic data

Description	Specification
Square Area	0.5 mm ² (AWG 20)
Linear Resistance	≤ 120 Ω/km
Max. Length (depends on total linear resistance)	< 500 Ω
Signal Run Time	≤ 5.3 ns/m
Insulation Resistance	≥ 200 MΩ*km
Characteristic Impedance 1 - 100	100 MHz (±5 Ω)
Attenuation @ 1 Mhz	< 2.9 dB/100 m
Operating Voltage (peak)	≤ 300 V
Test Voltage (wire/wire/screen rms 50 Hz 1 min)	= 700 V

Tab. 52: Signal cable recommendations (Electrical data at reference temperature (20 °C [68 °F]))



Description	Specification
Square Area	1.3 mm ² (AWG 16)
Max. Length	300 m (AWG 16)

Tab. 53: Signal cable recommendations

NOTE:

Size the cable length and diameter to provide 19,2 V DC at power terminals at load current of 0,75 A

Description	Specification
Glands	<ul style="list-style-type: none">• Material<ul style="list-style-type: none">- Nylon¹⁴⁾- Brass/Ni plated- Stainless steel AISI 316/1.4404• Cable cross section<ul style="list-style-type: none">- Ø 8 to 17 mm (0.31" to 0.67")- Ø 5 to 13 mm (0.20" to 0.51")
Entries	1 x ½" NPT (for current output/communication, channel 1) and 2 x ½" NPT (for supply and channels 2 to 4) M20x1.5

Tab. 54: Transmitter cable glands and entries

¹⁴⁾ If operating temperature is below -20 °C [-4 °F], use Brass/Ni plated or stainless steel cable glands.



11.7. Operating Conditions

Description	Specification
Ambient Temperature (Humidity max. 90 %)	<ul style="list-style-type: none"> • Operation in non-hazardous areas: -40 °C ... +60 °C [-40 °F ... +140 °F] • Operation in hazardous areas: see chapter 11.15, page 177 • Storage: -40 °C ... +70 °C [-40 °F ... +158 °F]
Climate class / Environmental conditions	DIN 60721-3-4
Altitude	Up to 2,000 m [6,560 ft]
Relative Humidity	95 %
EMC Performance	Emission: EN 55011/CISPR-11 Immunity: EN/IEC 61326-1 (Industry) NAMUR NE 21

Tab. 55: Basic conditions

Description	Specification
Cleaning Method	<ul style="list-style-type: none"> • CIP • SIP
Cleaning Temperature	On request
Cleaning Frequency	On request
Cleaning Duration	On request

Tab. 56: Cleaning and sterilizing conditions

Description	Specification
Process Media Temperature (Ts)	-60 °C ... +200 °C [-76 °F ... +392 °F]
Process Media Density	Up to 5.000 kg/m ³ [5,0 g/cm ³]
Pressure Drop	See "Pressure drop curves" from sizing program. Available on www.tricorflow.com

Tab. 57: Process media conditions



11.8. Process Variables

Description	Specification
Primary Process Variables	<ul style="list-style-type: none"> • Massflow • Density • Fluid temperature
Derived Process Variables	<ul style="list-style-type: none"> • Volumeflow • Corrected volumeflow • Fraction A:B • Fraction % A:B

Tab. 58: Process variables

11.9. Bus Communication

Description	Specification	More information
Manufacturer ID	24816 (60F0 Hex)	Manufacturer ID parameter
Device ID	34 (22 Hex)	Device type parameter
HART Protocol Revision	7.5	HART protocol revision parameter
Profibus Profile	4.0	Profibus protocol revision parameter
Modbus RS485 RTU	—	—
Number of Device Variables	11	Number of process values, both measured and derived
Physical Layers Supported	FSK	Frequency Shift Keying
Loop-Powered	No	4-wire device

Tab. 59: HART, MODBUS and Profibus communication

11.10. SD-Card

Description	Specification SD-Card
Capacity	4 GB
File System Support	FAT32 / 8.3
Temperature Range	Operation: -40 °C ... +85 °C [-40 °F ... +185 °F] Storage: -40 °C ... +100 °C [-40 °F ... +212 °F]

Tab. 60: SD-Card

NOTE:

SD-Card functions support

Only the supplied 4 GB SD cards are supported for backup, restore, logging, and firmware update.



11.11. PED (European Directive for pressure equipment)

The pressure equipment directive RL 2014/68/EU applies to the alignment of the statutory orders of the European member states for pressure equipment. Such equipment in the sense of the directive includes vessels, pipelines and accessories with a maximum allowable pressure of more than 0.5 bar above atmospheric. Coriolis Mass Flow Meters are considered as piping.







A detailed risk analysis of the flowmeter has been performed in accordance with the RL 2014/68/EU. All risks are assessed to be "none" provided that the procedures and standards referenced in these operating instructions are observed..

11.11.1. Division of media (liquid/gaseous) into the fluid groups

The classification of fluids on the basis of the new European Hazardous Substances Regulation is regulated in Article 13 of RL 2014/68/EU.

Fluids are gases, liquids and vapours as pure phase as well as their mixtures. Fluids can also contain a suspension of solids. According to the Pressure Equipment Directive, the fluid group is determined by the medium flowing or being in the component later. The directive distinguishes between two fluid groups:

Group 1 fluids

 <p>Explosive R phrases: for example: 2, 3 (1, 4, 5, 6, 9, 16, 18, 19, 44)</p>	 <p>Very toxic R phrases: for example: 26, 27, 28, 39 (32)</p>
 <p>Extremely flammable R phrases: for example: 12 (17)</p>	 <p>Toxic R phrases: for example: 23, 24, 25 (29, 31)</p>
 <p>Highly flammable R phrases: for example: 11, 15, 17 (10, 30)</p>	 <p>Oxidizing R phrases: for example: 7, 8, 9 (14, 15, 19)</p>
 <p>Flammable R phrases: for example: 11 (10)</p>	

Tab. 61: Fluids group 1 according to PED



Group 2 fluids

All fluids not belonging to Group 1.

Also applies to fluids which are for example dangerous to the environment, corrosive, dangerous to health, irritant or carcinogenic (if not highly toxic).

11.11.2. Conformity assessment

Flowmeters of categories I to III comply with the safety requirements of the directive. They are affixed with the CE mark and an EC declaration of conformity is provided.

The flowmeters are subjected to the conformity assessment procedure - Module A2.

Flowmeters according to Article 3 Paragraph 3 are designed and manufactured in accordance with sound engineering practice in Germany. PED conformity reference is not affixed to the CE mark.

11.11.3. Diagrams

- Gases of fluid group 1
- Pipelines according to Article 3 Number 1.3 Letter a) First dash
- Exception: unstable gases belonging to Categories I and II must be included in Category III.

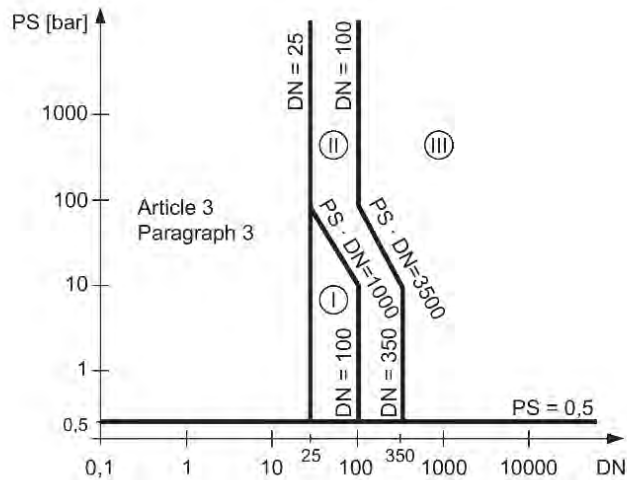

Fig. 95: Diagram 1 for gases of fluid group 1



- Gases of fluid group 2
- Pipelines according to Article 3 Number 1.3 Letter a) Second dash
- Exception: liquids at temperatures $> 350^{\circ} \text{C}$ belonging to Category II must be included in Category III.

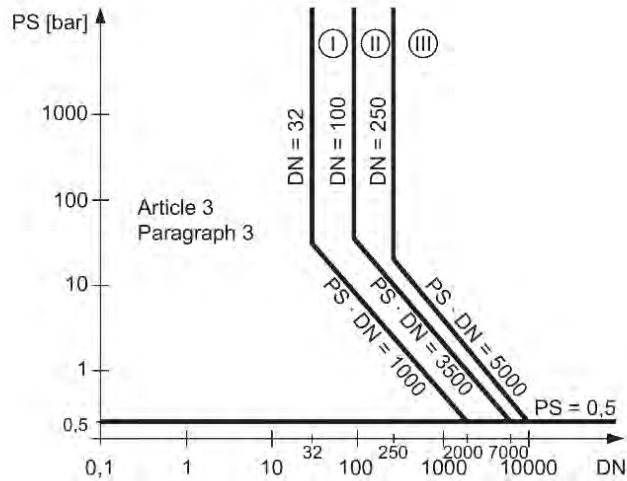

Fig. 96: Diagram 1 for gases of fluid group 2

- Liquids of fluid group 1
- Pipelines according to Article 3 Number 1.3 Letter b) First dash

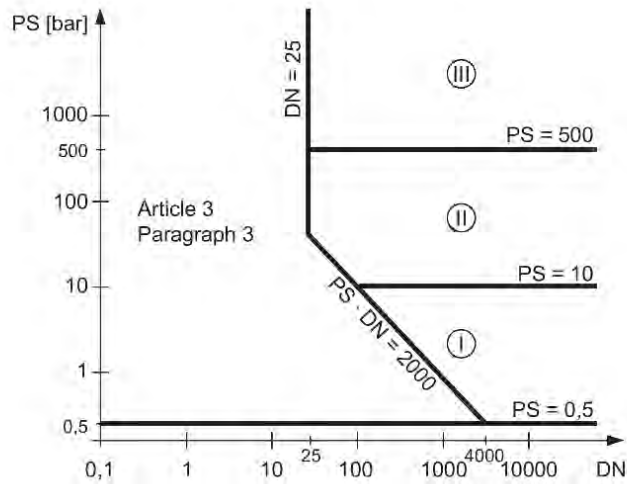

Fig. 97: Diagram 2 for gases of fluid group 1

- Liquids of fluid group 2
- Pipelines according to Article 3 Number 1.3 Letter b) Second dash

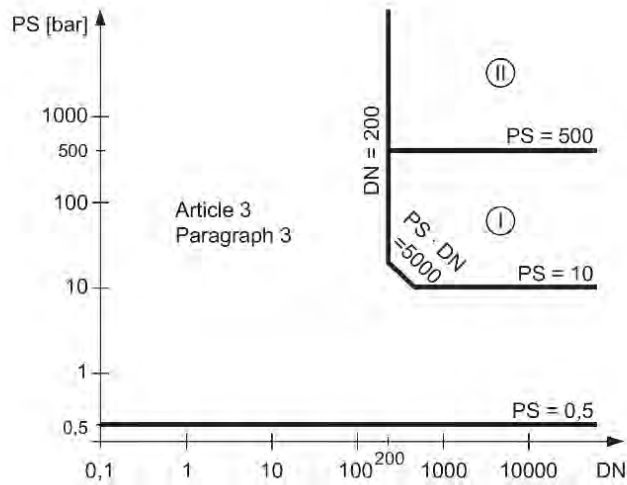

Fig. 98: Diagram 2 for gases of fluid group 2

11.12. Pressure – temperature ratings

Pressure – temperature ratings are determined by process connection material and applicable standards. The tables below detail the allowed maximum process pressure for sensor variants with stainless steel and Hastelloy measuring tubes.

With two major exceptions, the pressure rating of the flow sensors is independent of the process medium temperature. Design rules for flange connections in both the EN1092-1 and ASME B16.5 standards dictate pressure derating with increasing temperature. The charts below show the effect of process medium temperature on the pressure ratings for the flanges within the product program.

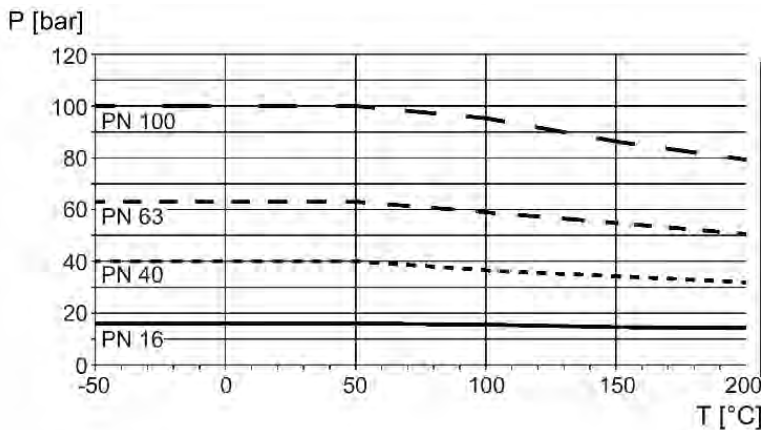

Fig. 99: Metric flange ratings, EN 1092-1 (P: Process pressure; T: Process temperature)

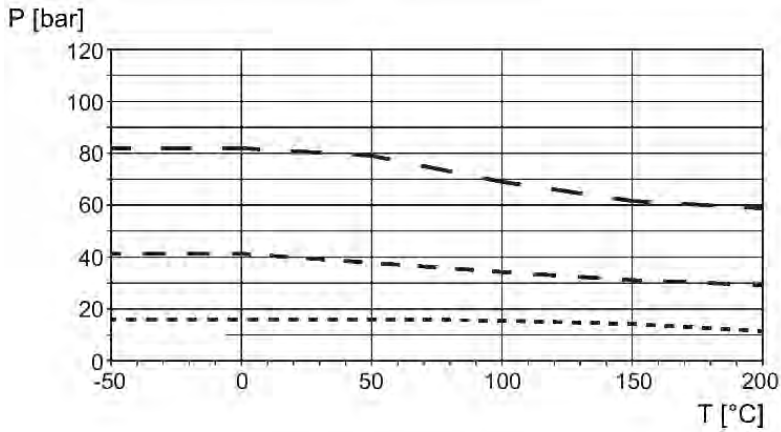

Fig. 100: ANSI flange ratings, ASME B16.5 (P: Process pressure; T: Process temperature)

PN	Temperature TS (°C [°F])					
	-50 [-58]	0 [+32]	+50 [+122]	+100 [+212]	+150 [+302]	+180 [+356]
16 bar [232 psi]	16.0 bar [232.1 psi]	16.0 bar [232.1 psi]	16.0 bar [232.1 psi]	15.2 bar [220.5 psi]	13.7 bar [198.7 psi]	13.1 bar [190.0 psi]
40 bar [580 psi]	40.0 bar [580.2 psi]	40.0 bar [580.2 psi]	40.0 bar [580.2 psi]	37.9 bar [549.7 psi]	34.5 bar [500.4 psi]	32.9 bar [477.2 psi]
63 bar [915 psi]	63.0 bar [913.7 psi]	63.0 bar [913.7 psi]	63.0 bar [913.7 psi]	59.7 bar [865.9 psi]	54.3 bar [787.6 psi]	51.8 bar [751.3 psi]
100 bar [1,450 psi]	100.0 bar [1,450.4 psi]	100.0 bar [1,450.4 psi]	100.0 bar [1,450.4 psi]	94.8 bar [1,375.0 psi]	86.1 bar [1,248.8 psi]	82.1 bar [1,190.8 psi]
160 bar [2,320 psi]	110 bar [1,595.4 psi]					

Tab. 62: Pressure - temperature rating according to EN1092-1

PN	Temperature TS (°C [°F])					
	-50 [-58]	0 [+32]	+50 [+122]	+100 [+212]	+150 [+302]	+180 [+356]
110 bar [1,595 psi]	110 bar [1,595.4 psi]					

Tab. 63: Pressure - temperature rating according to ISO228-G and ASME B1.20.1 NPT



Class/Group	Temperature TS (°C [°F])					
	-50 [-58]	0 [+32]	+50 [+122]	+100 [+212]	+150 [+302]	+180 [+356]
150 / 2.2	19.0 bar [275.6 psi]	19.0 bar [275.6 psi]	18.4 bar [226.9 psi]	16.2 bar [235.0 psi]	14.8 bar [214.7 psi]	13.7 bar [198.7 psi]
300 / 2.2	49.6 bar [719.4 psi]	49.6 bar [719.4 psi]	48.1 bar [697.6 psi]	42.2 bar [612.1 psi]	38.5 bar [558.4 psi]	35.7 bar [517.8 psi]
600 / 2.2	99.3 bar [1,440.2 psi]	99.3 bar [1,440.2 psi]	96.2 bar [1,395.3 psi]	84.4 bar [1,224.1 psi]	77.0 bar [1,116.8 psi]	71.3 bar [1,034.1 psi]
900 / 2.2	110.0 bar [1,595.4 psi]	110.0 bar [1,595.4 psi]	110.0 bar [1,595.4 psi]	110.0 bar [1,595.4 psi]	110.0 bar [1,595.4 psi]	107.0 bar [1,595.4 psi]

Tab. 64: Pressure - temperature rating according to ASME B16.5

PN	Temperature TS (°C [°F])					
	-50 [-58]	0 [+32]	+50 [+122]	+120 [+248]	+150 [+302]	+200 [+392]
10 K	14.0 bar [203.1 psi]	14.0 bar [203.1 psi]	14.0 bar [203.1 psi]	14.0 bar [203.1 psi]	13.4 bar [194.4 psi]	12.4 bar [179.8 psi]
20 K	34.0 bar [493.1 psi]	34.0 bar [493.1 psi]	34.0 bar [493.1 psi]	34.0 bar [493.1 psi]	33.1 bar [480.1 psi]	31.6 bar [458.3 psi]
40 K	68.0 bar [986.3 psi]	68.0 bar [986.3 psi]	68.0 bar [986.3 psi]	68.0 bar [986.3 psi]	66.2 bar [960.1 psi]	63.2 bar [916.6 psi]
63 K	100.0 bar [1,450.4 psi]	100.0 bar [1,450.4 psi]	100.0 bar [1,450.4 psi]	100.0 bar [1,450.4 psi]	100.0 bar [1,450.4 psi]	99.0 bar [1,435.9 psi]

Tab. 65: Pressure - temperature rating according to JIS

PN/DN	Temperature TS (°C [°F])				
	-50 [-58]	0 [+32]	+50 [+122]	+100 [+212]	+140 [+284]
25 bar [363 psi] / 50-100	25.0 bar [362.6 psi]	25.0 bar [362.6 psi]	25.0 bar [362.6 psi]	25.0 bar [362.6 psi]	25.0 bar [362.6 psi]
40 bar [580 psi] / 10-40	40.0 bar [580.2 psi]	40.0 bar [580.2 psi]	40.0 bar [580.2 psi]	40.0 bar [580.2 psi]	40.0 bar [580.2 psi]

Tab. 66: Pressure - temperature rating according to DIN 11851



PN/DN	Temperature TS (°C [°F])				
	-50 [-58]	0 [+32]	+50 [+122]	+100 [+212]	+140 [+284]
10 bar [145 psi] / 85-219.1	10.0 bar [145.0 psi]	10.0 bar [145.0 psi]	10.0 bar [145.0 psi]	10.0 bar [145.0 psi]	10.0 bar [145.0 psi]
16 bar [232 psi] / 48.3-76.2	16.0 bar [232.1 psi]	16.0 bar [232.1 psi]	16.0 bar [232.1 psi]	16.0 bar [232.1 psi]	16.0 bar [232.1 psi]
25 bar [363 psi] / 6.35-42.4	25.0 bar [362.6 psi]	25.0 bar [362.6 psi]	25.0 bar [362.6 psi]	25.0 bar [362.6 psi]	25.0 bar [362.6 psi]

Tab. 67: Pressure - temperature rating according to DIN 32676 & ISO 2852

PN/DN	Temperature TS (°C [°F])				
	-50 [-58]	0 [+32]	+50 [+122]	+100 [+212]	+140 [+284]
25 bar [363 psi] / 50-100	25.0 bar [362.6 psi]	25.0 bar [362.6 psi]	25.0 bar [362.6 psi]	25.0 bar [362.6 psi]	25.0 bar [362.6 psi]
40 bar [580 psi] / 10-40	40.0 bar [580.2 psi]	40.0 bar [580.2 psi]	40.0 bar [580.2 psi]	40.0 bar [580.2 psi]	40.0 bar [580.2 psi]

Tab. 68: Pressure - temperature rating according to ISO 2853

DN	Temperature TS (°C [°F])				
	-50 [-58]	0 [+32]	+50 [+122]	+100 [+212]	+140 [+284]
50-80	25.0 bar [362.6 psi]	25.0 bar [362.6 psi]	25.0 bar [362.6 psi]	25.0 bar [362.6 psi]	25.0 bar [362.6 psi]
15-25	40.0 bar [580.2 psi]	40.0 bar [580.2 psi]	40.0 bar [580.2 psi]	40.0 bar [580.2 psi]	40.0 bar [580.2 psi]

Tab. 69: Pressure - temperature rating according to DIN 11864-1

DN	Temperature TS (°C [°F])				
	-50 [-58]	0 [+32]	+50 [+122]	+100 [+212]	+140 [+284]
50-80	16.0 bar [232.1 psi]	16.0 bar [232.1 psi]	16.0 bar [232.1 psi]	16.0 bar [232.1 psi]	16.0 bar [232.1 psi]
15-25	25.0 bar [362.6 psi]	25.0 bar [362.6 psi]	25.0 bar [362.6 psi]	25.0 bar [362.6 psi]	25.0 bar [362.6 psi]

Tab. 70: Pressure - temperature rating according to DIN 11864-2



DN	Temperature TS (°C [°F])				
	-50 [-58]	0 [+32]	+50 [+122]	+100 [+212]	+140 [+284]
80	16.0 bar [232.1 psi]	16.0 bar [232.1 psi]	16.0 bar [232.1 psi]	16.0 bar [232.1 psi]	16.0 bar [232.1 psi]
50	25.0 bar [362.6 psi]	25.0 bar [362.6 psi]	25.0 bar [362.6 psi]	25.0 bar [362.6 psi]	25.0 bar [362.6 psi]
15-25	40.0 bar [580.2 psi]	40.0 bar [580.2 psi]	40.0 bar [580.2 psi]	40.0 bar [580.2 psi]	40.0 bar [580.2 psi]

Tab. 71: Pressure - temperature rating according to DIN 11864-3

PN	Temperature TS (°C [°F])					
	-50 [-58]	0 [+32]	+50 [+122]	+100 [+212]	+150 [+302]	+200 [+392]
100 bar [1450 psi]	100.0 bar [1,450.4 psi]	100.0 bar [1,450.4 psi]	100.0 bar [1,450.4 psi]	100.0 bar [1,450.4 psi]	100.0 bar [1,450.4 psi]	100.0 bar [1,450.4 psi]

Tab. 72: Pressure - temperature rating according to Swagelok SS-12-VCO-3 socket weld with SS-12-VCO-4 nut

NOTE

Test pressure

Maximum allowable test pressure (MATP) for the flowmeter and process connection is 1.5 times the nominal pressure up to 150 bar (2,176 psi).



11.13. Sensor Dimensions

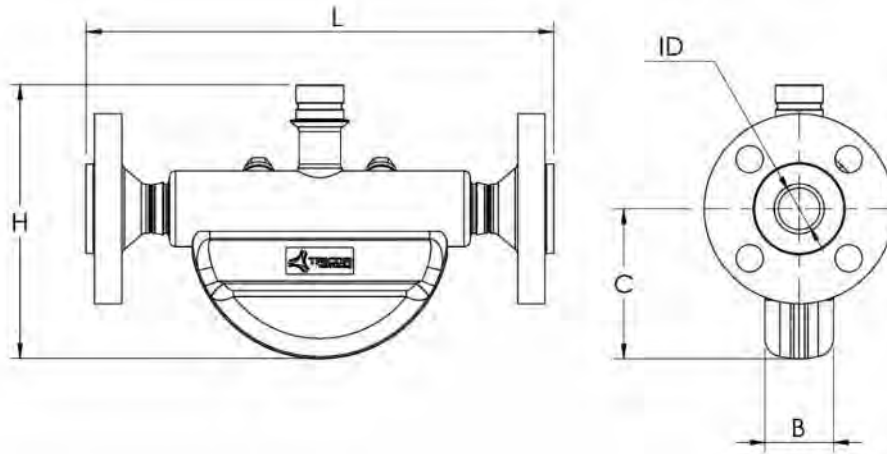

Sensor Type	B	C	H	L ¹⁵⁾	I.D.	Connection ¹⁶⁾
TCMQ 6400	50 mm [2.0 in]	90 mm [3.54 in]	231 mm [9.09 in]	see page 22	on request	on request
TCMQ 018K	56 mm [2.2 in]	123 mm [4.84 in]	330 mm [12.99 in]	see page 22	on request	on request
TCMQ 070K	95 mm [3.7 in]	187 mm [7.36 in]	622 mm [24.49 in]	see page 22	on request	on request

Fig. 101: Dimensions TCMQ 6400 through TCMQ 070K

11.14. Transmitter Dimensions

Dimensional Drawing TCD 9010 Compact Transmitter

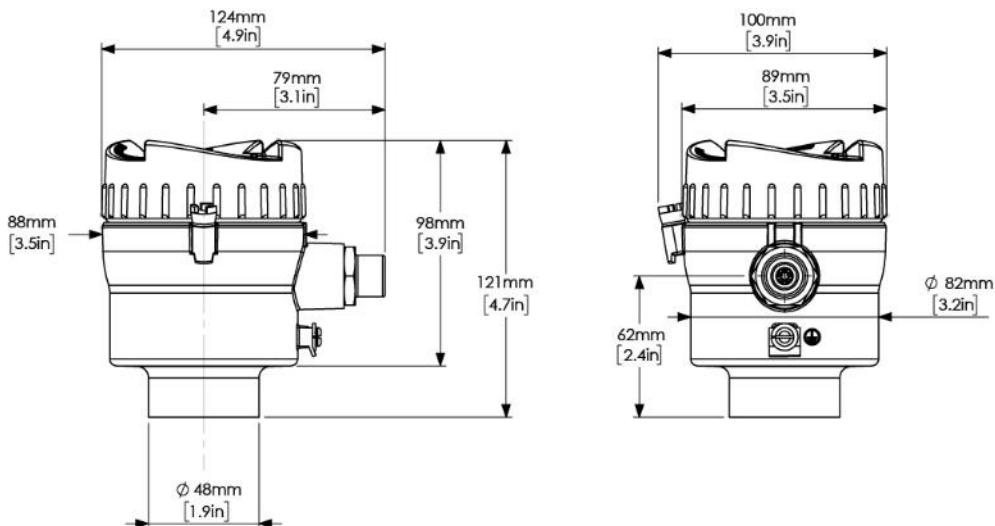

Fig. 102: Dimensions TCD 9010 Compact Transmitter

¹⁵⁾ Other connections on request.

¹⁶⁾ Further lengths on request.



11.15. Certificates¹⁷⁾

Description	Specification
ATEX	<p>TCMQ with TCD 9010 can be installed in Zone 1 for gas : Certificate: CSANe 20ATEX1077</p> <p>Markings:</p> <ul style="list-style-type: none"> ● II 1/2 G Ex db ia IIC T* Ga/Gb ● II 1/2 G Ex db IIC T* Ga/Gb ● II 1 D Ex ia IIIC T* °C Da/Db ● II 2 D Ex tb IIIC T* °C Db <p>Ta = -40 °C to +** °C ,upper Ta refer to “Use in Hazardous Areas” (chapter 2.4.3.1, page 15)</p>
	<p>TCMQ with TCD 9100/9200 can be installed in Zone 1 for gas : Certificate: CSANe 20ATEX1078</p> <p>Markings:</p> <ul style="list-style-type: none"> ● II 1/2 (1) G Ex db eb ia [ia Ga] IIC T* Ga/Gb ● II 2 (1) D Ex tb [ia Da] IIIC T* Db <p>Ta = -40 °C to +** °C ,upper Ta refer to “Use in Hazardous Areas” (chapter 2.4.3.2, page 16)</p>
IECEX	<p>TCMQ with TCD 9010 can be installed in Zone 1 for gas: Certificate: IECEX SIR 20.0014X</p> <p>Markings:</p> <ul style="list-style-type: none"> ● Ex db ia IIC T3-T6 Ga/Gb ● Ex db IIC T3-T6 Ga/Gb ● Ex ia IIIC T* Da ● Ex tb IIIC T* Db <p>Ta = -40 °C to +** °C, upper Ta refer to “Use in Hazardous Areas” (chapter 2.4.3.1, page 15)</p>
	<p>TCMQ with TCD 9100/9200 can be installed in Zone 1 for gas : Certificate: IECEX SIR 20.0015X</p> <p>Markings:</p> <ul style="list-style-type: none"> ● Ex db eb ia [ia Ga] IIC T3-T6 Ga/Gb ● Ex tb [ia Da] IIIC T* Db Ta = -40 °C to +** °C <p>upper Ta refer to “Use in Hazardous Areas” (chapter 2.4.3.2, page 16)</p>

¹⁷⁾ T* refer to Ex-certificate.



Description	Specification
cCSAus	<p>TCMQ with TCD9010 can be installed in C1/Z1 and C1D1 for gas: Certificate: 70209633 Canadian markings:</p> <ul style="list-style-type: none">● Ex db ia IIC T3-T6 Gb● Ex tb IIIC T135°C Db● Ex ia IIIC T135°C Da <p>US markings:</p> <ul style="list-style-type: none">● Class I, II, III, Division 1, Groups A, B, C, D, E, F, G● Class I, Zone 1, AEx db ia IIC T3-T6 Gb● Zone 21, AEx tb IIIC T135°C Db● Zone 20, AEx ia IIIC T135°C Da <hr/> <p>TCMQ with TCD9100/9200 can be installed in Zone 1 for gas : Certificate: 70209632 Canadian markings:</p> <ul style="list-style-type: none">● Ex db eb ia [ia Ga] IIC T3-T6 Gb● Ex tb [ia Da] IIC T85°C <p>US markings:</p> <ul style="list-style-type: none">● Class I, II, III, Division 1, Groups A, B, C, D, E, F, G● Class I, Zone 1, AEx db eb ia [ia Ga] IIC T3-T6 Gb● Zone 21, AEx tb [ia Da] IIC T85°C

Tab. 73: Certificates TCMQ Series



12. Listings

12.1. Warranty

For warranty refer to the general terms and conditions of KEM Küppers Elektromechanik GmbH, which can be found on the corresponding website (www.kem-kueppers.com), respectively for the Americas those of AW Lake Company (www.aw-lake.com).

12.2. Certificates and Support

12.2.1. Technical Support

If you have any technical questions about the device described in these Operating Instructions and do not find the right answers, you can contact Customer Support:

- Via the Internet using the Support Request:
 - Support request (www.tricorflow.com)
- Via the local companies:
 - US/Canada: www.aw-lake.com
 - Rest of the world: www.kem-kueppers.com

Service and support on the internet

In addition to our documentation, we offer a comprehensive knowledge base online on the Internet at:

Service and support: <https://tricorflow.com/support/>

There you will find:

- The latest product information, general inquiries, downloads, tips and tricks
- Our newsletter, providing you with the latest information about your products

12.2.2. Certificates

You can find certificates on the Internet at online support portal (<https://tricorflow.com/certifications/>) or with the product shipment.

Certification documents including calibration report are supplied with each sensor included on the SD-Card. Material, pressure test, and factory conformance certificates are optional at ordering.

12.3. WEEE and RoHS

The TRICOR Coriolis Mass Flow Meter described herein is not subject to the WEEE directive and the corresponding national laws. At the end of life forward the TCMQ to a specialized recycling company and do not dispose it off as domestic waste.

The TCMQ described herein fully complies with the RoHS directive.

12.4. Menu Structure

12.4.1. Main Menu

In the following table only the menus and parameters of the first two levels of the HMI menu structure are listed.

Level 1		Level 2		More information
No.	Name	No.	Name	
1	Quick Start	1.1	Quick Commissioning	Quick Commissioning Wizard (menu item 1.1) (Page 67)
		1.2	Zero Point Adjustment	Zero Point Adjustment Wizard (menu item 1.2) (Page 68)
		1.3	Process Values	Process Values Wizard (menu item 1.3) (Page 70)
		1.4	Inputs and outputs	Inputs/Outputs Wizard (menu item 1.4) (Page 71)
		1.5	Gas Application	Gas Application Wizard (menu item 1.5) (Page 75)
		1.6	Pulsating Flow	Pulsating Flow Wizard (menu item 1.6) (Page 76)
		1.7	Dosing Application	Dosing Application Wizard (menu item 1.7) (Page 77)
		1.8	Copy configuration	How do I copy application setup from one device to another? (Page 152)
		1.9	Communication	Menu item "Communication" (4) (Page 209)
2	Setup	2.1	Sensor	Menu Item "Sensor" (2.1) (Page 182)
		2.2	Process values	Menu Item "Process values" (2.2) (Page 183)
		2.3	Totalizer	Menu Item "Totalizer" (2.3) (Page 186)
		2.4	Inputs and outputs	Menu Item "Inputs and outputs" (2.4) (Page 187)
		2.5	Dosing	Menu Item „Dosing“ (2.5) (Page 193)
		2.7	Date and time	Menu Item „Date and time“ (2.7) (Page 198)
		2.8	Local display	Menu Item „Display“ (2.8) (Page 198)



Level 1		Level 2		More information
No.	Name	No.	Name	
3	Maintenance & Diagnostics	3.1	Identification	Menu Item „Identification“ (3.1) (Page 200)
		3.2	Diagnostic events	Menu Item "Diagnostic events" (3.2) (Page 201)
		3.3	Maintenance	Menu item "Maintenance" (3.3) (Page 202)
		3.4	Diagnostics	Menu item "Diagnostic" (3.4) (Page 203)
		3.5	Peak values	Menu item "Peak values" (3.5) (Page 204)
		3.6	Charateristics	Menu item "Characteristics" (3.6) (Page 205)
		3.7	Sensor flash	Menu item "SD-Card" (3.7) (Page 206)
		3.8	Simulation	Menu item "Simulation" (3.8) (Page 207)
		3.9	Audit trail	Menu item "Audit trail" (3.9) (Page 208)
		3.10	Self test	Menu item "Self test" (3.10) (Page 208)
		3.11	Resets	Menu item "Resets" (3.11) (Page 208)
		3.12	Firmware update	Menu item "Firmware update" (3.12) (Page 208)
4	Communication (Page 209)	4.1	USB (Service channel)	
		4.2	HART (channel 1)	
		4.3	Modbus (channel 1)	
		4.4	Profibus DP/PA	
5	Security (Page 210)	5.1	Change user PIN	
		5.2	Change expert PIN	
		5.3	Recovery ID	
		5.4	PIN recovery	
		5.5	Activate user PIN	
		5.6	Deactivate user PIN	
		5.7	Auto logout	
		5.8	Logout	
6	Language			

Tab. 74: Main menu



12.4.2. Menu Item “Sensor” (2.1)

Level 3		Level 4		More information
No.	Name	No.	Name	
2.1.1	Flow direction			
2.1.2	Noise damping			
2.1.3	Zero point adjustment	2.1.3.1	Select zero point adjustment	
		2.1.3.2	Zero point adjustment	
		2.1.3.3	Duration	
		2.1.3.4	Standard deviation limit	
		2.1.3.5	Standard deviation	
		2.1.3.6	Offset limit	
		2.1.3.7	Offset	
2.1.4	Aerated flow	2.1.4.1	Aerated flow filter	
		2.1.4.2	Filter time constant	
		2.1.4.3	Alarm limit	
		2.1.4.4	Warning limit	
		2.1.4.5	Measurement sample Time	
		2.1.4.6	Filter hysteresis	
		2.1.4.7	Minimum filter time	
		2.1.4.8	Filter iteration	
		2.1.4.9	Bandwidth factor	
		2.1.4.10	Filter pole shift	

Tab. 75: Menu items “Sensor”: basic settings



12.4.3. Menu Item “Process values” (2.2)

Level 3		Level 4		Level 5			
No.	Name	No.	Name	No.	Name		
2.2.1	Mass flow	2.2.1.1	Units				
		2.2.1.2	Custom units				
		2.2.1.3	Custom conversion factor				
		2.2.1.4	Decimal places				
		2.2.1.5	Low flow cut-off				
		2.2.1.6	Alarm and warning limits	2.2.1.6.1	Upper alarm limit		
				2.2.1.6.2	Upper warning limit		
				2.2.1.6.3	Lower warning limit		
				2.2.1.6.4	Lower alarm limit		
				2.2.1.6.5	Hysteresis		
2.2.1.7	Flow adjustment	2.2.1.7.1	Adjustment factor				
2.2.2	Volume flow	2.2.2.1	Units				
		2.2.2.2	Custom units				
		2.2.2.3	Custom conversion factor				
		2.2.2.4	Decimal places				
		2.2.2.5	Low flow cut-off				
		2.2.2.6	Alarm and warning limits	2.2.2.6.1	Upper alarm limit		
				2.2.2.6.2	Upper warning limit		
				2.2.2.6.3	Lower warning limit		
				2.2.2.6.4	Lower alarm limit		
				2.2.2.6.5	Hysteresis		
2.2.3	Standard Volumeflow	2.2.3.1	Units				
		2.2.3.2	Custom units				
		2.2.3.3	Custom conversion factor				
		2.2.3.4	Decimal places				
		2.2.3.5	Alarm and warning limits	2.2.3.5.1	Upper alarm limit		
				2.2.3.5.2	Upper warning limit		
				2.2.3.5.3	Lower warning limit		
				2.2.3.5.4	Lower alarm limit		
				2.2.3.5.5	Hysteresis		
		2.2.3.6	Standard density	2.2.3.6.1	Unit		
2.2.3.6.2	Standard volume flow mode						



Level 3		Level 4		Level 5			
No.	Name	No.	Name	No.	Name		
				2.2.3.6.3	Fixed standard density		
				2.2.3.6.4	Linear expansion coeff.		
				2.2.3.6.5	Square expansion coeff.		
				2.2.3.6.6	Standard temperature		
				2.2.3.6.7	Upper alarm limit standard density		
				2.2.3.6.8	Upper alarm limit standard density		
				2.2.3.6.9	Lower alarm limit standard density		
				2.2.3.6.10	Lower alarm limit standard density		
				2.2.3.6.11	Alarm hysteresis standard density		
2.2.5	Density	2.2.5.1	Units				
		2.2.5.2	Custom units				
		2.2.5.3	Custom conversion factor				
		2.2.5.4	Decimal places				
		2.2.5.5	Alarm and warning limits	2.2.5.5.1	Upper alarm limit		
				2.2.5.5.2	Upper warning limit		
				2.2.5.5.3	Lower warning limit		
				2.2.5.5.4	Lower alarm limit		
				2.2.5.5.5	Hysteresis		
		2.2.5.6	Density adjustment	2.2.5.6.1	Adjustment Factor		
2.2.5.6.2	Fraction offset						
2.2.5.7	Empty tube detection						
2.2.5.8	Empty tube limit						
2.2.6	Medium temperature	2.2.6.1	Units				
		2.2.6.2	Decimal places				
		2.2.6.3	Alarm and warning limits	2.2.6.3.1	Upper alarm limit		
				2.2.6.3.2	Upper warning limit		
				2.2.6.3.3	Lower warning limit		
				2.2.6.3.4	Lower alarm limit		
				2.2.6.3.5	Hysteresis		
2.2.7	Fraction (optional)	2.2.7.1	Measurement Mode				
		2.2.7.2	Unit				
		2.2.7.3	Active fraction table				



Level 3		Level 4		Level 5	
No.	Name	No.	Name	No.	Name
		2.2.7.4	Fraction Name		
		2.2.7.5	Fraction A	2.2.7.5.1	Fraction A label
				2.2.7.5.2	Upper Limit Alarm
				2.2.7.5.3	Upper Limit Warning
				2.2.7.5.4	Lower Limit Warning
				2.2.7.5.5	Lower Limit Alarm
				2.2.7.5.6	Alarm Hysteresis
				2.2.7.5.7	Decimal Places
		2.2.7.6	Fraction B	2.2.7.6.1	Fraction B label
				2.2.7.6.2	Upper Limit Alarm
				2.2.7.6.3	Upper Limit Warning
				2.2.7.6.4	Lower Limit Warning
				2.2.7.6.5	Lower Limit Alarm
				2.2.7.6.6	Alarm Hysteresis
				2.2.7.6.7	Decimal Places
		2.2.7.7	Fraction A %	2.2.7.7.1	Upper Limit Alarm
				2.2.7.7.2	Upper Limit Warning
				2.2.7.7.3	Lower Limit Warning
				2.2.7.7.4	Lower Limit Alarm
				2.2.7.7.5	Alarm Hysteresis
				2.2.7.7.6	Decimal Places
		2.2.7.8	Fraction B %	2.2.7.8.1	Upper Limit Alarm
				2.2.7.8.2	Upper Limit Warning
				2.2.7.8.3	Lower Limit Warning
				2.2.7.8.4	Lower Limit Alarm
				2.2.7.8.5	Alarm Hysteresis
				2.2.7.8.6	Decimal Places
		2.2.7.9	Fraction Adjustment	2.2.7.9.1	Adjustment Factor
				2.2.7.9.2	Fraction offset

Tab. 76: Menu items "Process values"

12.4.4. Menu Item “Totalizer” (2.3)

Level 3		Level 4		Level 5	
No.	Name	No.	Name	No.	Name
2.3.1	Totalizer 1	2.3.1.1	Process value		
		2.3.1.2	Unit		
		2.3.1.3	Custom units		
		2.3.1.4	Custom conversion factor		
		2.3.1.5	Decimal places		
		2.3.1.6	Flow direction		
		2.3.1.7	Fail safe behaviour		
		2.3.1.8	Reset		
		2.3.1.9	Preset		
		2.3.1.10	Alarm and warning limits	2.3.1.10.1	Upper alarm limit
		2.3.1.10.2	Upper warning limit		
		2.3.1.10.3	Lower warning limit		
		2.3.1.10.4	Lower alarm limit		
		2.3.1.10.5	Hysteresis		
2.3.2	Totalizer 2	2.3.2.1	Process Value		
		2.3.2.2	Unit		
		2.3.2.3	Custom units		
		2.3.2.4	Custom conversion factor		
		2.3.2.5	Decimal places		
		2.3.2.6	Flow direction		
		2.3.2.7	Fail safe behaviour		
		2.3.2.8	Reset		
		2.3.2.9	Preset		
		2.3.2.10	Alarm and warning limits	2.3.2.10.1	Upper alarm limit
		2.3.2.10.2	Upper warning limit		
		2.3.2.10.3	Lower warning limit		
		2.3.2.10.4	Lower alarm limit		
		2.3.2.10.5	Hysteresis		
2.3.3	Totalizer 3	2.3.3.1	Process Value		
		2.3.3.2	Unit		
		2.3.3.3	Custom units		
		2.3.3.4	Custom conversion factor		
		2.3.3.5	Decimal places		



Level 3		Level 4		Level 5			
No.	Name	No.	Name	No.	Name		
		2.3.3.6	Flow direction				
		2.3.3.7	Fail safe behaviour				
		2.3.3.8	Reset				
		2.3.3.9	Preset				
		2.3.2.10	Alarm and warning limits	2.3.3.10.2	Upper warning limit		
				2.3.3.10.3	Lower warning limit		
				2.3.3.10.4	Lower alarm limit		
				2.3.3.10.5	Hysteresis		
		2.3.4	Reset All Totalizers				

Tab. 77: Menu items “Totalizer”

12.4.5. Menu Item “Inputs and outputs” (2.4)

12.4.5.1. Current output on CH1

Level 3		Level 4		Level 5	
No.	Name	No.	Name	No.	Name
2.4.1	CH1 - output with HART (optinal)	2.4.1.1	Loop current mode		
		2.4.1.2	Active operation		
		2.4.1.3	PV selection		
		2.4.1.4	Direction		
		2.4.1.5	Loop current scale		
		2.4.1.6	Upper range value		
		2.4.1.7	Lower range value		
		2.4.1.8	Fail safe activation condition		
		2.4.1.9	Damping value		
		2.4.1.10	Fail-safe behaviour		
		2.4.1.11	Fail Safe Value (optional)		
		2.4.1.12	Fail-safe minimum duration		

Tab. 78: Menu items “Current output on CH1”

NOTE

Menu item visibility

The availability in the HMI of the menu items for channels 2, 3 and 4 depend on the I/O configuration.

12.4.5.2. Signal Output on CH2

Level 3		Level 4		Level 5			
No.	Name	No.	Name	No.	Name		
2.4.2	CH2 - output	2.4.2.1	Operation mode				
		2.4.3.2	Change operation mode				
		2.4.2.3	Active operation				
		2.4.2.4	Fail-safe activation condition				
		2.4.2.5	Current output	2.4.2.5.1	Process value		
				2.4.2.5.2	Flow direction		
				2.4.2.5.3	Loop current scale		
				2.4.2.5.4	Upper range value		
				2.4.2.5.5	Lower range value		
				2.4.2.5.6	Damping value		
				2.4.2.5.7	Fail-safe behavior		
				2.4.2.5.8	Fail-safe value		
				2.4.2.5.9	Fail-safe minimum duration		
		2.4.2.6	Frequency output	2.4.2.6.1	Process value		
				2.4.2.6.2	Flow direction		
				2.4.2.6.3	Upper frequency value		
				2.4.2.6.4	Lower frequency value		
				2.4.2.6.5	Upper range value		
				2.4.2.6.6	Lower range value		
				2.4.2.6.7	Damping value		
				2.4.2.6.8	Fail-safe behavior		
				2.4.2.6.9	Fail-safe value		
				2.4.2.6.10	Fail-safe minimum duration		
		2.4.2.7	Pulse output	2.4.2.7.1	Process value		
				2.4.2.7.2	Flow direction		
				2.4.2.7.3	Pulse units		
				2.4.2.7.4	Amount		
				2.4.2.7.5	Pulses per amount		
2.4.2.7.6	Pulse width units						
2.4.2.7.7	Pulse width						
2.4.2.7.8	Polarity						
2.4.2.7.9	Fail-safe behavior						
2.4.2.7.10	Fail-safe value						



Level 3		Level 4		Level 5	
No.	Name	No.	Name	No.	Name
				2.4.2.7.11	Fail-safe minimum duration
		2.4.2.8	Digital output	2.4.2.8.1	Mode
				2.4.2.8.2	Sensor alarms (group 1)
				2.4.2.8.3	Sensor alarms (group 2)
				2.4.2.8.4	Process alarms (1)
				2.4.2.8.5	Process alarms (2)
				2.4.2.8.8	Totalizers alarms
				2.4.2.8.9	Device alarms
				2.4.2.8.10	Channel 1 alarms
				2.4.2.8.11	Input/output alarms (1)
				2.4.2.8.13	Simulation alarms (1)
				2.4.2.8.14	Simulation alarms (2)
				2.4.2.8.15	Alarm class
				2.4.2.8.16	NAMUR status signal
				2.4.2.8.17	Polarity
				2.4.2.8.18	On-delay
				2.4.2.8.19	Off-delay

Tab. 79: Menu items "Signal output on CH2"

12.4.5.3. Input/Output on CH3

Level 3		Level 4		Level 5	
No.	Name	No.	Name	No.	Name
2.4.3	CH3 - input/output	2.4.3.1	Operation mode		
		2.4.3.2	Change operation mode		
		2.4.3.3	Active operation		
		2.4.3.4	Fail-safe activation condition		
		2.4.3.5	Current Output	2.4.3.5.1	Process value
				2.4.3.5.2	Flow direction
				2.4.3.5.3	Loop current scale
				2.4.3.5.4	Upper range value
				2.4.3.5.5	Lower range value
				2.4.3.5.6	Damping value
				2.4.3.5.7	Fail-safe behavior
				2.4.3.5.8	Fail-safe value

Level 3		Level 4		Level 5	
No.	Name	No.	Name	No.	Name
				2.4.3.5.9	Fail-safe minimum duration
		2.4.3.6	Frequency output	2.4.3.6.1	Redundancy mode
				2.4.3.6.2	Process value
				2.4.3.6.3	Flow direction
				2.4.3.6.4	Upper frequency value
				2.4.3.6.5	Lower frequency value
				2.4.3.6.6	Upper range value
				2.4.3.6.7	Lower range value
				2.4.3.6.8	Damping value
				2.4.3.6.9	Fail-safe behavior
				2.4.3.6.10	Fail-safe value
				2.4.3.6.11	Fail-safe minimum duration
		2.4.3.7	Pulse output	2.4.3.7.1	Redundancy mode
				2.4.3.7.2	Process value
				2.4.3.7.3	Flow direction
				2.4.3.7.4	Pulse units
				2.4.3.7.5	Amount
				2.4.3.7.6	Pulses per amount
				2.4.3.7.7	Pulse width units
				2.4.3.7.8	Pulse width
				2.4.3.7.9	Polarity
				2.4.3.7.10	Fail-safe behavior
				2.4.3.7.11	Fail-safe value
				2.4.3.7.12	Fail-safe minimum duration
		2.4.3.8	Digital output	2.4.3.8.1	Mode
				2.4.3.8.2	Sensor alarms (group 1)
				2.4.3.8.3	Sensor alarms (group 2)
				2.4.3.8.4	Process alarms (1)
				2.4.3.8.5	Process alarms (2)
				2.4.3.8.8	Totalizers alarms
				2.4.3.8.9	Device alarms
				2.4.3.8.10	Channel 1 alarms
				2.4.3.8.11	Input/output alarms (1)
				2.4.3.8.13	Simulation alarms (1)



Level 3		Level 4		Level 5	
No.	Name	No.	Name	No.	Name
				2.4.3.8.14	Simulation alarms (2)
				2.4.3.8.15	Alarm class
				2.4.3.8.16	NAMUR status signal
				2.4.3.8.17	Polarity
				2.4.3.8.18	On-delay
				2.4.3.8.19	Off-delay
		2.4.3.9	Digital input	2.4.3.9.1	Input function
				2.4.3.9.2	CH1 forced current value
				2.4.3.9.3	CH2 forced current value
				2.4.3.9.4	CH3 forced current value
				2.4.3.9.5	CH4 forced current value
				2.4.3.9.6	Debounce time
				2.4.3.9.7	Polarity

Tab. 80: Menu items "Input/output on CH3"

12.4.5.4. Input/output on CH4

Level 3		Level 4		Level 5	
No.	Name	No.	Name	No.	Name
2.4.4	CH4 - input/output	2.4.4.1	Operation Mode		
		2.4.3.2	Change operation mode		
		2.4.4.3	Active operation		
		2.4.4.4	Fail-safe activation condition		
		2.4.4.5	Current output	2.4.5.4.1	Process value
				2.4.5.4.2	Flow direction
				2.4.5.4.3	Loop current scale
				2.4.5.4.4	Upper range value
				2.4.5.4.5	Lower range value
				2.4.5.4.6	Damping value
				2.4.5.4.7	Fail-safe behavior
				2.4.5.4.8	Fail-safe value
				2.4.5.4.9	Fail-safe minimum duration
		2.4.4.6	Frequency output	2.4.5.6.1	Process value
				2.4.5.6.2	Flow direction
				2.4.5.6.3	Upper frequency value
				2.4.5.6.4	Lower frequency value

Level 3		Level 4		Level 5	
No.	Name	No.	Name	No.	Name
				2.4.5.6.5	Upper range value
				2.4.5.6.6	Lower range value
				2.4.5.6.7	Damping value
				2.4.5.6.8	Fail-safe behavior
				2.4.5.6.9	Fail-safe value
				2.4.5.6.10	Fail-safe minimum duration
		2.4.4.7	Pulse output	2.4.5.7.1	Process value
				2.4.5.7.2	Flow direction
				2.4.5.7.3	Pulse units
				2.4.5.7.4	Amount
				2.4.5.7.5	Pulses per amount
				2.4.5.7.6	Pulse width units
				2.4.5.7.7	Pulse width
				2.4.5.7.8	Polarity
				2.4.5.7.9	Fail-safe behavior
				2.4.5.7.10	Fail-safe value
				2.4.5.7.11	Fail-safe minimum duration
		2.4.4.8	Digital output	2.4.5.8.1	Mode
				2.4.5.8.2	Sensor alarms (group 1)
				2.4.5.8.3	Sensor alarms (group 2)
				2.4.5.8.4	Process alarms (1)
				2.4.5.8.5	Process alarms (2)
				2.4.5.8.8	Totalizers alarms
				2.4.5.8.9	Device alarms
				2.4.5.8.10	Channel 1 alarms
				2.4.5.8.11	Input/output alarms (1)
				2.4.5.8.13	Simulation alarms (1)
				2.4.5.8.14	Simulation alarms (2)
				2.4.5.8.15	Alarm class
				2.4.5.8.16	NAMUR status signal
				2.4.5.8.17	Polarity
				2.4.5.8.18	On-delay
				2.4.5.8.19	Off-delay
		2.4.4.9	Digital input	2.4.5.9.1	Input function
				2.4.5.9.2	CH1 forced current value
				2.4.5.9.3	CH2 forced current value
				2.4.5.9.4	CH3 forced current value



Level 3		Level 4		Level 5	
No.	Name	No.	Name	No.	Name
				2.4.5.9.5	CH4 forced current value
				2.4.5.9.6	Debounce time
				2.4.5.9.7	Polarity
2.4.6	CH4 - relay	2.4.6.1	Operation Mode		
		2.4.6.2	Mode		
		2.4.6.3	Sensor alarms (group 1)		
		2.4.6.4	Sensor alarms (group 2)		
		2.4.6.5	Process alarms (1)		
		2.4.6.6	Process alarms (2)		
		2.4.6.9	Totalizers alarms		
		2.4.6.10	Device alarms		
		2.4.6.11	Channel 1 alarms		
		2.4.6.12	Input/output alarms (1)		
		2.4.6.14	Simulation alarms (1)		
		2.4.6.15	Simulation alarms (2)		
		2.4.6.16	Alarm class		
		2.4.6.17	NAMUR status signal		
		2.4.6.18	Polarity		
		2.4.6.19	On-delay		
		2.4.6.20	Off-delay		

Tab. 81: Menu items "Input/output on CH4"

12.4.6. Menu Item „Dosing“ (2.5)

Level 3		Level 4		Level 5	
No.	Name	No.	Name	No.	Name
2.5.1	Dosing mode				
2.5.2	Process value				
2.5.3	Active recipe				
2.5.5	Recipe 1				
2.5.6	Recipe 2				
2.5.7	Recipe 3				
2.5.8	Recipe 4				
2.5.9	Recipe 5				

Tab. 82: Menu items "Dosing"

12.4.6.1. Recipe 1

Level 3		Level 4		Level 5	
No.	Name	No.	Name	No.	Name
2.5.5	Recipe 1	2.5.5.1	Name		
		2.5.5.2	Unit		
		2.5.5.3	Amount		
		2.5.5.4	Decimal Places		
		2.5.5.5	User calibration	2.5.5.5.1	Fixed compensation
		2.5.5.6	Valve Control	2.5.5.6.1	Stage Setup Format
				2.5.5.6.2	Value to open primary valve
				2.5.5.6.3	Value to close primary valve
				2.5.5.6.4	Value to open secondary valve
				2.5.5.6.5	Value to close secondary valve
				2.5.5.6.6	Current value to close
				2.5.5.6.7	Current value to partially open
				2.5.5.6.8	Current value to fully open
				2.5.5.6.9	Amount for fully open
				2.5.5.6.10	Amount for partially open
		2.5.5.7	Fault Handling	2.5.5.7.1	Duration Mode
				2.5.5.7.2	Duration Time
2.5.5.7.3	Overrun Mode				
2.5.5.7.4	Overrun Value				

Tab. 83: Menu items "Recipe 1"



12.4.6.2. Recipe 2

Level 3		Level 4		Level 5	
No.	Name	No.	Name	No.	Name
2.5.6	Recipe 2	2.5.6.1	Name		
		2.5.6.2	Unit		
		2.5.6.3	Amount		
		2.5.6.4	Decimal Places		
		2.5.6.5	User calibration	2.5.6.5.1	Fixed compensation
		2.5.6.6	Valve Control	2.5.6.6.1	Stage Setup Format
				2.5.6.6.2	Value to open primary valve
				2.5.6.6.3	Value to close primary valve
				2.5.6.6.4	Value to open secondary valve
				2.5.6.6.5	Value to close secondary valve
				2.5.6.6.6	Current value to close
				2.5.6.6.7	Current value to partially open
				2.5.6.6.8	Current value to fully open
				2.5.6.6.9	Amount for fully open
				2.5.6.6.10	Amount for partially open
		2.5.6.7	Fault Handling	2.5.6.7.1	Duration Mode
2.5.6.7.2	Duration Time				
2.5.6.7.3	Overrun Mode				
2.5.6.7.4	Overrun Value				

Tab. 84: Menu items "Recipe 2"

12.4.6.3. Recipe 3

Level 3		Level 4		Level 5	
No.	Name	No.	Name	No.	Name
2.5.7	Recipe 3	2.5.7.1	Name		
		2.5.7.2	Unit		
		2.5.7.3	Amount		
		2.5.7.4	Decimal Places		
		2.5.7.5	User calibration	2.5.7.5.1	Fixed compensation

Level 3		Level 4		Level 5	
No.	Name	No.	Name	No.	Name
		2.5.7.6	Valve Control	2.5.7.6.1	Stage Setup Format
				2.5.7.6.2	Value to open primary valve
				2.5.7.6.3	Value to close primary valve
				2.5.7.6.4	Value to open secondary valve
				2.5.7.6.5	Value to close secondary valve
				2.5.7.6.6	Current value to close
				2.5.7.6.7	Current value to partially open
				2.5.7.6.8	Current value to fully open
				2.5.7.6.9	Amount for fully open
				2.5.7.6.10	Amount for partially open
		2.5.7.7	Fault Handling	2.5.7.7.1	Duration Mode
				2.5.7.7.2	Duration Time
				2.5.7.7.3	Overrun Mode
				2.5.7.7.4	Overrun Value

Tab. 85: Menu items "Recipe 3"

12.4.6.4. Recipe 4

Level 3		Level 4		Level 5	
No.	Name	No.	Name	No.	Name
2.5.8	Recipe 4	2.5.8.1	Name		
		2.5.8.2	Unit		
		2.5.8.3	Amount		
		2.5.8.4	Decimal Places		
		2.5.8.5	User calibration	2.5.8.5.1	Fixed compensation
		2.5.8.6	Valve Control	2.5.8.6.1	Stage Setup Format
				2.5.8.6.2	Value to open primary valve
				2.5.8.6.3	Value to close primary valve
				2.5.8.6.4	Value to open secondary valve



Level 3		Level 4		Level 5	
No.	Name	No.	Name	No.	Name
				2.5.8.6.5	Value to close secondary valve
				2.5.8.6.6	Current value to close
				2.5.8.6.7	Current value to partially open
				2.5.8.6.8	Current value to fully open
				2.5.8.6.9	Amount for fully open
				2.5.8.6.10	Amount for partially open
		2.5.8.7	Fault Handling	2.5.8.7.1	Duration Mode
				2.5.8.7.2	Duration Time
				2.5.8.7.3	Overrun Mode
				2.5.8.7.4	Overrun Value

Tab. 86: Menu items "Recipe 4"

12.4.6.5. Recipe 5

Level 3		Level 4		Level 5	
No.	Name	No.	Name	No.	Name
2.5.9	Recipe 5	2.5.9.1	Name		
		2.5.9.2	Unit		
		2.5.9.3	Amount		
		2.5.9.4	Decimal Places		
		2.5.9.5	User calibration	2.5.9.5.1	Fixed compensation
		2.5.9.6	Valve Control	2.5.9.6.1	Stage Setup Format
				2.5.9.6.2	Value to open primary valve
				2.5.9.6.3	Value to close primary valve
				2.5.9.6.4	Value to open secondary valve
				2.5.9.6.5	Value to close secondary valve
				2.5.9.6.6	Current value to close
				2.5.9.6.7	Current value to partially open
				2.5.9.6.8	Current value to fully open



Level 3		Level 4		Level 5	
No.	Name	No.	Name	No.	Name
				2.5.9.6.9	Amount for fully open
				2.5.9.6.10	Amount for partially open
		2.5.9.7	Fault Handling	2.5.9.7.1	Duration Mode
				2.5.9.7.2	Duration Time
				2.5.9.7.3	Overrun Mode
				2.5.9.7.4	Overrun Value

Tab. 87: Menu items "Recipe 5"

12.4.7. Menu Item „Date and time“ (2.7)

Level 3		Level 4		Level 5	
No.	Name	No.	Name	No.	Name
2.7.1	Current data and time				
2.7.2	Set date and time				

Tab. 88: Menu items "Date and time"

12.4.8. Menu Item „Display“ (2.8)

Level 3		Level 4		Level 5	
No.	Name	No.	Name	No.	Name
2.8.1	Brightness				
2.8.2	Backlight				
2.8.3	Contrast				
2.8.4	Damping	2.8.4.1	Damping value		
		2.8.4.2	Process values		
2.8.5	View 1	2.8.5.1	Type		
		2.8.5.2	1st value		
		2.8.5.3	2nd value		
		2.8.5.4	3rd value		
		2.8.5.5	4th value		
		2.8.5.6	5th value		
		2.8.5.7	6th value		
		2.8.5.8	Scale mode		
		2.8.5.9	Log time window		
		2.8.5.10	Scale lower limit		
		2.8.5.11	Scale upper limit		



Level 3		Level 4		Level 5	
No.	Name	No.	Name	No.	Name
2.8.6	View 2	2.8.6.1	Enable or disable		
		2.8.6.2	Type		
		2.8.6.3	1st value		
		2.8.6.4	2nd value		
		2.8.6.5	3rd value		
		2.8.6.6	4th value		
		2.8.6.7	5th value		
		2.8.6.8	6th value		
		2.8.6.9	Scale mode		
		2.8.6.10	Log time window		
		2.8.6.11	Scale lower limit		
		2.8.6.12	Scale upper limit		
2.8.7	View 3	2.8.7.1	Enable or disable		
		2.8.7.2	Type		
		2.8.7.3	1st value		
		2.8.7.4	2nd value		
		2.8.7.5	3rd value		
		2.8.7.6	4th value		
		2.8.7.7	5th value		
		2.8.7.8	6th value		
		2.8.7.9	Scale mode		
		2.8.7.10	Log time window		
		2.8.7.11	Scale lower limit		
		2.8.7.12	Scale upper limit		
2.8.8	View 4	2.8.7.1	Enable or disable		
		2.8.7.2	Type		
		2.8.7.3	1st value		
		2.8.7.4	2nd value		
		2.8.7.5	3rd value		
		2.8.7.6	4th value		
		2.8.7.7	5th value		
		2.8.7.8	6th value		
		2.8.7.9	Scale mode		
		2.8.7.10	Log time window		
		2.8.8.11	Scale lower limit		
		2.8.8.12	Scale upper limit		
2.8.9	View 5	2.8.9.1	Enable or disable		

Level 3		Level 4		Level 5	
No.	Name	No.	Name	No.	Name
		2.8.9.2	Type		
		2.8.9.3	1st value		
		2.8.9.4	2nd value		
		2.8.9.5	3rd value		
		2.8.9.6	4th value		
		2.8.9.7	5th value		
		2.8.9.8	6th value		
		2.8.9.9	Scale mode		
		2.8.9.10	Log time window		
		2.8.9.11	Scale lower limit		
		2.8.9.12	Scale upper limit		
		2.8.10	View 6	2.8.10.1	Enable or disable
2.8.10.2	Type				
2.8.10.3	1st value				
2.8.10.4	2nd value				
2.8.10.5	3rd value				
2.8.10.6	4th value				
2.8.10.7	5th value				
2.8.10.8	6th value				
2.8.10.9	Scale mode				
2.8.10.10	Log time window				
2.8.10.11	Scale lower limit				
2.8.10.12	Scale upper limit				
2.8.11	Status icons				

Tab. 89: Menu items "Display"

12.4.9. Menu Item „Identification“ (3.1)

Level 3		Level 4		Level 5	
No.	Name	No.	Name	No.	Name
3.1.1	Long tag				
3.1.2	Descriptor				
3.1.3	Message				
3.1.4	Location				
3.1.5	Installation date				
3.1.6	Manufacturer				
3.1.7	Product name				



Level 3		Level 4		Level 5	
No.	Name	No.	Name	No.	Name
3.1.8	Product variant				
3.1.9	Order number				
3.1.10	Serial number				
3.1.11	FW revision				
3.1.12	HW revision				
3.1.13	Final assembly number				
3.1.15	Transmitter electronics	3.1.15.1	HW version		
		3.1.15.2	FW version		
		3.1.15.3	Serial number		
		3.1.15.4	Order number		
		3.1.15.5	Communication interface HW version		
		3.1.15.6	Communication interface serial number		
3.1.16	Local display	3.1.16.1	HW version		
		3.1.16.2	FW version		
		3.1.16.3	HMI cfg. version		
3.1.17	I/O electronics	3.1.17.1	HW version		
		3.1.17.2	FW version		
		3.1.17.3	Serial number		
3.1.19	Sensor	3.1.19.1	Type		
		3.1.19.2	Size		
		3.1.19.3	Order number		
		3.1.19.4	Serial number		

Tab. 90: Menu items "Identification"

12.4.10. Menu Item "Diagnostic events" (3.2)

Level 3		Level 4		Level 5	
No.	Name	No.	Name	No.	Name
3.2.1	Active diagnostic events				
3.2.2	Diagnostic log				
3.2.3	Clear diagnostic log				
3.2.4	Alarm acknowledge mode				
3.2.5	Transmitter detailed events				

Level 3		Level 4		Level 5	
No.	Name	No.	Name	No.	Name
3.2.6	Suppression time	3.2.7.1	Sensor alarms (group 1)		
		3.2.7.2	Sensor alarms (group 2)		
		3.2.7.3	Process alarms (group 1)		
		3.2.7.4	Process alarms (group 2)		
		3.2.7.7	Totalizers events		
		3.2.7.8	Device events		
		3.2.7.9	Simulation alarms (group 1)		
		3.2.7.10	Simulation alarms (group 2)		
		3.2.7.11	Input/output alarms (group 1)		
		3.2.7.13	Dosing alarms		
3.2.8	Alarm class assignment	3.2.8.8	148 Transm. temp above alarm limit		
		3.2.8.9	149 Transm. temp above alarm limit		

Tab. 91: Menu items "Diagnostic events"

12.4.11. Menu item "Maintenance" (3.3)

Level 3		Level 4		Level 5	
No.	Name	No.	Name	No.	Name
3.3.1	Copy configuration				
3.3.2	Spare part replacement	3.3.2.1	Transmitter	3.3.2.1.1	Replace transmitter
				3.3.2.1.2	Replace transmitter cassette
				3.3.2.1.3	Replace sensor cassette (Compact)
		3.3.2.2	Sensor	3.3.2.2.1	Replace TCD 9010
				3.3.2.2.2	Replace sensor cassette
3.3.3	Operating time	3.3.3.1	Operating time		
		3.3.3.2	Operating time total		

Tab. 92: Menu items "Maintenance"

**NOTE****Spare part replacement**

Menu item 3.3.2 (Spare Part Replacement) is only visible if access level is Expert.

12.4.12. Menu item "Diagnostic" (3.4)

Level 3		Level 4		Level 5			
No.	Name	No.	Name	No.	Name		
3.4.1	Sensor	3.4.1.1	Driver current				
		3.4.1.2	Pickup S1 amplitude				
		3.4.1.3	Pickup S2 amplitude				
		3.4.1.4	Max. pickup amplitude diff				
		3.4.1.5	Derived frequency				
		3.4.1.6	Offset				
3.4.2	Temperature monitoring	3.4.2.1	Medium temperature	3.4.2.1.1	Current value		
				3.4.2.2.1	Current value		
		3.4.2.2	Transmitter electronics temperature	3.4.2.2.2	Minimum		
				3.4.2.2.3	Timestamp at minimum		
				3.4.2.2.4	Maximum		
				3.4.2.2.5	Timestamp at maximum		
				3.4.2.3	TCD 9010 temperature	3.4.2.3.1	Current value
		3.4.2.4	Sensor frame temperature	3.4.2.4.1	Current value		
		3.4.3	Inputs and outputs	3.4.3.1	Channel 1 – output with HART	3.4.3.1.1	Loop current
						3.4.3.1.2	Error status
3.4.3.2	Channel 2 – output			3.4.3.2.1	Operation mode		
				3.4.3.2.2	Loop current		
				3.4.3.2.3	Digital output signal		
				3.4.3.2.4	Totalized amount		
				3.4.3.2.5	Output frequency		
				3.4.3.2.6	Error status		
				3.4.3.2.7	Pulse counter		
				3.4.3.2.8	Reset pulse counter		
3.4.3.3	Channel 3 – input/output			3.4.3.3.1	Operation mode		
				3.4.3.3.2	Digital input value		
				3.4.3.3.3	Totalized amount		
				3.4.3.3.4	Output frequency		
				3.4.3.3.5	Digital output signal		

Level 3		Level 4		Level 5	
No.	Name	No.	Name	No.	Name
				3.4.3.3.6	Loop current
				3.4.3.3.7	Error status
				3.4.3.3.8	Pulse counter
				3.4.3.3.9	Reset pulse counter
		3.4.3.4	Channel 4 – input/output	3.4.3.4.1	Operation mode
				3.4.3.4.2	Digital input value
				3.4.3.4.2	Totalized amount
				3.4.3.4.2	Output frequency
				3.4.3.4.2	Digital output signal
				3.4.3.4.2	Loop current
				3.4.3.4.3	Error status
				3.4.3.4.4	Pulse counter
				3.4.3.4.5	Reset pulse counter
		3.4.3.5	Channel 4 – relay	3.4.3.5.1	Digital output signal

Tab. 93: Menu items "Diagnostic"

12.4.13. Menu item "Peak values" (3.5)

Level 3		Level 4		Level 5	
No.	Name	No.	Name	No.	Name
3.5.1	Process value 1	3.5.1.1	Process value		
		3.5.1.2	Minimum		
		3.5.1.3	Timestamp at minimum		
		3.5.1.4	Maximum		
		3.5.1.5	Timestamp at maximum		
		3.5.1.6	Reset		
3.5.2	Process value 2	3.5.2.1	Process value		
		3.5.2.2	Minimum		
3.5.3	Process value 3	3.5.3.1	Process value		
		3.5.3.2	Minimum		
		3.5.3.3	Timestamp at minimum		
		3.5.3.4	Maximum		
		3.5.3.5	Timestamp at maximum		
		3.5.3.6	Reset		
3.5.3	Process value 4	3.5.4.1	Process value		
		3.5.4.2	Minimum		
		3.5.4.3	Timestamp at minimum		



Level 3		Level 4		Level 5	
No.	Name	No.	Name	No.	Name
		3.5.4.4	Maximum		
		3.5.4.5	Timestamp at maximum		
		3.5.4.6	Reset		

Tab. 94: Menu items "Peak values"

12.4.14. Menu item "Characteristics" (3.6)

Level 3		Level 4		Level 5	
No.	Name	No.	Name	No.	Name
3.6.1	SIL Variant				
3.6.2	CT Variant				
3.6.3	CT Active				
3.6.4	Transmitter	3.6.4.1	Composition		
		3.6.4.2	Hazardous area Approval		
3.6.6	Sensor	3.6.6.1	Hazardous area Approval		
		3.6.6.2	Maximum massflow capacity		
		3.6.6.3	Calibration factor		
		3.6.6.4	Density calibration offset		
		3.6.6.5	Density calibration factor		
		3.6.6.6	Density compensation tube temperature		
		3.6.6.7	Density compensation sensor frame temperature		
		3.6.6.8	Wetted materials		
3.6.7	Fraction order code				

Tab. 95: Menu items "Characteristics"

12.4.15. Menu item "SD-Card" (3.7)

Level 3		Level 4		Level 5			
No.	Name	No.	Name	No.	Name		
3.7.1	Eject						
3.7.2	installed						
3.7.3	Capacity						
3.7.4	Free space						
3.7.5	Data logging	3.7.5.1	Activation				
		3.7.5.2	Data logging mode				
		3.7.5.3	Logging interval				
		3.7.5.4	Process values	3.7.5.4.1	Logging value 1		
				3.7.5.4.2	Logging value 2		
				3.7.5.4.3	Logging value 3		
				3.7.5.4.4	Logging value 4		
				3.7.5.4.5	Logging value 5		
				3.7.5.4.6	Logging value 6		
				3.7.5.4.7	Logging value 7		
				3.7.5.4.8	Logging value 8		
				3.7.5.4.9	Logging value 9		
				3.7.5.4.10	Logging value 10		
				3.7.5.4.11	Logging value 11		
				3.7.5.4.12	Logging value 12		
				3.7.5.4.13	Logging value 13		
				3.7.5.4.14	Logging value 14		
				3.7.5.4.15	Logging value 15		
				3.7.5.4.16	Logging value 16		
				3.7.5.4.17	Logging value 17		
				3.7.5.4.18	Logging value 18		
		3.7.5.4.19	Logging value 19				
3.7.5.4.20	Logging value 20						
3.7.5.5	Advanced logging	3.7.5.5.1	Register 1				
		3.7.5.5.2	Register 2				
		3.7.5.5.3	Register 3				
		--	--				
		--	--				
		--	--				
3.7.5.5.90	Register 90						

Tab. 96: Menu items "SD-Card"



12.4.16. Menu item "Simulation" (3.8)

Level 3		Level 4		Level 5	
No.	Name	No.	Name	No.	Name
3.8.1	Simulation inputs and outputs	3.8.1.1	CH1 - output with HART	3.7.1.1.1	Simulation
				3.7.1.1.2	Simulation value
				3.8.1.2.1	Operation mode
		3.8.1.2	CH2 - output	3.8.1.2.2	Simulation
				3.8.1.2.3	Simulation value
				3.7.1.3.1	Operation mode
		3.8.1.3	CH3 - input/output	3.7.1.3.2	Simulation
				3.7.1.3.3	Simulation value
				3.8.1.5.1	Operation mode
		3.7.1.4	CH4 - input/output	3.8.1.5.2	Simulation
				3.8.1.6.3	Simulation value
				3.8.1.6.1	Simulation
		3.7.1.5	CH4 - relay	3.8.1.6.2	Simulation value
		3.8.2	Simulation process values	3.8.2.1	Enable Simulation
3.8.2.2	Mass flow			3.8.2.2.1	Simulation value
3.8.2.3	Volume flow			3.8.2.3.1	Simulation value
3.8.2.4	Standard volume flow			3.8.2.4.1	Simulation value
3.8.2.5	Density			3.8.2.6.1	Simulation value
3.8.2.6	Medium temperature			3.8.2.7.1	Simulation value
3.8.2.7	Fraction A % value			3.8.2.9.1	Simulation value
3.8.2.8	Fraction B % value			3.8.2.10.1	Simulation value
3.8.3	Simulation alarms	3.8.3.1	Simulation mode		
		3.8.3.2	Alarms	3.8.3.2.1	Simulation sensor alarms (1)
				3.8.3.2.2	Simulation sensor alarms (2)
				3.8.3.2.4	Process alarms (1)
				3.8.3.2.5	Process alarms (2)
				3.8.3.2.8	Totalizer alarms
				3.8.3.2.9	Device alarms
				3.8.3.2.10	Channel 1 alarms
				3.8.3.2.11	Input/output alarms (1)
		3.8.3.2.13	Dosing alarms		
3.8.3.3	Alarm class				
3.8.3.3	NAMUR status signal				

Tab. 97: Menu items "Simulation"

12.4.17. Menu item "Audit trail" (3.9)

Level 3		Level 4		Level 5	
No.	Name	No.	Name	No.	Name
3.9.1	Parameter change log				
3.9.2	Clear parameter change log				
3.9.3	FW update change log				
3.9.4	Clear FW update change log				

Tab. 98: Menu items "Audit trail"

12.4.18. Menu item "Self test" (3.10)

Level 3		Level 4		Level 5	
No.	Name	No.	Name	No.	Name
3.10.1	Display test				

Tab. 99: Menu items "Self test"

12.4.19. Menu item "Resets" (3.11)

Level 3		Level 4		Level 5	
No.	Name	No.	Name	No.	Name
3.11.1	Factory reset				
3.11.2	Device restart				

Tab. 100: Menu items "Resets"

12.4.20. Menu item "Firmware update" (3.12)

Level 3		Level 4		Level 5	
No.	Name	No.	Name	No.	Name
3.12	Firmware update				

Tab. 101: Menu items "Firmware update"



12.4.21. Menu item "Communication" (4)

Level 3		Level 4		Level 5			
No.	Name	No.	Name	No.	Name		
4.1	USB (Service channel)	4.1.1	USB mode				
		4.1.2	Auto connection				
		4.1.3	MSD connent				
4.2	HART (CH1)	4.2.1	Polling address (SW)				
		4.2.2	Polling address (HW)				
		4.2.3	Tag				
		4.2.4	Hart device type				
		4.2.5	HART revision				
		4.2.6	Number of response preambles				
		4.2.7	Dynamic variable mapping	4.2.7.1	SV selection		
				4.2.7.2	TV selection		
				4.2.7.3	QV-Selector		
		4.2.8	Hart units	4.2.8.1	Mass flow units		
				4.2.8.2	Volume flow units comms		
				4.2.8.3	Standard volume flow units		
				4.2.8.4	Fraction units		
				4.2.8.8	Density units		
				4.2.8.11	Temperature units		
4.2.8.13	Totalizer 1 units						
4.2.9	Damping	4.2.9.1	Damping value				
		4.2.9.2	Process values (1)				
		4.2.9.3	Process values (2)				
4.3	Modbus (Kanal 1)	4.3.1	Slave address (SW)				
		4.3.2	Slave address (HW)				
		4.3.3	Restart communication				
		4.3.4	Data rate				
		4.3.5	Parity and stopbits				
		4.3.6	Floating point byte error				
		4.3.7	Integer byte order				
		4.3.8	Register mapping				
		4.3.9	Modbus units	4.3.9.1	Mass flow units		

Level 3		Level 4		Level 5	
No.	Name	No.	Name	No.	Name
				4.3.9.2	Volume flow units comms
				4.3.9.3	Standard volume flow units
				4.3.9.4	Fraction mass flow units
				4.3.9.8	Density units
				4.3.9.11	Temperature units
				4.3.9.13	Totalizer 1 units
				4.3.9.14	Totalizer 2 units
				4.3.9.15	Totalizer 3 units
		4.3.10	Damping	4.3.10.0	Damping value
				4.3.10.1	Process values (1)
				4.3.10.2	Process values (2)
4.4	PROFIBUS DP/PA	4.4.1	Slave address		

Tab. 102: Menu items "Communication"

12.4.22. Menu item "Security" (5)

Level 3		Level 4		Level 5	
No.	Name	No.	Name	No.	Name
5.1	Change user PIN				
5.2	Change expert PIN				
5.3	Recovery ID				
5.4	PIN recovery				
5.5	Activate user PIN				
5.6	Deactivate user PIN				
5.7	Auto logout				

Tab. 103: Menu items "Security"



12.5. List of Figures

Fig. 1: Compact version	8
Fig. 2: Remote version	8
Fig. 3: Compact version with TCD 9010 transmitter	18
Fig. 4: Compact version with TCD 9100 transmitter	18
Fig. 5: Remote version with TCD 9200 transmitter	18
Fig. 6: Overview compact configuration.....	19
Fig. 7: Transmitter exploded view	20
Fig. 8: Principle of operation Coriolis Mass Flow Meter.....	26
Fig. 9: Mounting on wall	30
Fig. 10: Mounting on pipe	30
Fig. 11: Mounting the transmitter.....	30
Fig. 12: Turning the TCD 9100 transmitter (compact version) - Horizontal rotation	31
Fig. 13: Turning the TCD 9200 Display (remote version) - Horizontal rotation.....	31
Fig. 14: Turning the TCD 9200 display - Vertical rotation (remote version).....	32
Fig. 15: Turning the local display	32
Fig. 16: Liquid applications, wrong location with trapped air/gas	33
Fig. 17: Gas applications, wrong location with trapped oil	33
Fig. 18: Vertical orientation, upwards flow	34
Fig. 19: Liquid applications, wrong location with trapped air/gas	34
Fig. 20: Horizontal orientation; tubes up	35
Fig. 21: Installation in drop line	35
Fig. 22: Sensor installation with non-flexible pipes is not recommended in vibrating environment	36
Fig. 23: Flexible pipes recommended in vibrating environment.....	36
Fig. 24: High risk of cross talk when using non-flexible pipes	37
Fig. 25: Flexible pipes recommended in vibrating environment.....	37
Fig. 26: Sensor installation in sanitary applications (US market only)	37
Fig. 27: Cable end	45
Fig. 28: Electrical terminals TCD 9010	46
Fig. 29: Flexible strap TCD 9010 transmitter	47
Fig. 30: Electrical terminals TCMQ.....	48
Fig. 31: Configuration label.....	49
Fig. 32: Terminal layout	49
Fig. 33: Termination/configuration overview.....	50
Fig. 34: Wiring tool location	50
Fig. 35: Connecting the Current HART, CH1	51
Fig. 36: Connecting the Modbus (CH1).....	52
Fig. 37: Connecting the Profibus (CH1).....	53
Fig. 38: Connecting I/O-channels 2 to 4	54
Fig. 39: Open power supply terminal	56
Fig. 40: Connect ground and power	56
Fig. 41: Identification nameplate.....	59
Fig. 42: TCMQ sensor identification nameplate	60
Fig. 43: TCD 9*** transmitter specification nameplate	61
Fig. 44: TCD 9*** transmitter approval nameplate	62
Fig. 45: TCMQ sensor approval nameplate	62
Fig. 46: Design of the display/HMI	65
Fig. 47: Best practice zero point adjustment with a bypass line and two shut-off devices	67
Fig. 48: HMI wizard graphics.....	69
Fig. 49: Local user interface.....	79



Fig. 50: How to navigate between measurement views and alarm views	82
Fig. 51: HMI menu: Select access level	84
Fig. 52: Example HMI view	85
Fig. 53: Measurement view – Single value	86
Fig. 54: Measurement view – Three values	86
Fig. 55: Measurement view – One value and bargraph	87
Fig. 56: Measurement view – One value and graph	87
Fig. 57: Measurement view – Six values	88
Fig. 58: Operating view – Totalizer (level 1)	88
Fig. 59: Operating view – Totalizer (level 2)	89
Fig. 60: Operating view – Dosing (level 1)	89
Fig. 61: Operating view – Dosing (level 2)	90
Fig. 62: Alarm view – Alarm list (level 1)	90
Fig. 63: Alarm view – Alarm list (level 2)	91
Fig. 64: Alarm view – Alarm list (level 3)	91
Fig. 65: Diagnostic view – Six diagnostic values	92
Fig. 66: Example of display in navigation view	93
Fig. 67: Menu in navigation view ("Quick start" selected "Setup" not selected)	93
Fig. 68: Navigation view ReadWrite	94
Fig. 69: Navigation view ReadOnly	94
Fig. 70: Numeric parameter edit view	94
Fig. 71: Numeric parameter read only view	96
Fig. 72: List Selection edit view	96
Fig. 73: List selection read only view	97
Fig. 74: Multiselection view	97
Fig. 75: Hysteresis	100
Fig. 76: Centrifugal pump (1: low)	104
Fig. 77: Triplex pump (2)	104
Fig. 78: Duplex pump (3; default setting)	105
Fig. 79: Simplex pump (4)	105
Fig. 80: Cam pump (5: high)	105
Fig. 81: Current limits for NAMUR configuration	107
Fig. 82: Positive flow with negative scaling	108
Fig. 83: Positive flow across zero with positive scaling	109
Fig. 84: Bidirectional flow across zero with positive scaling	110
Fig. 85: Bidirectional flow with symmetrical scaling	111
Fig. 86: Positive flow - Channel 3 leads by 90°	113
Fig. 87: Negative flow - Channel 3 lags by 90°	113
Fig. 88: Positive flow - Channel 3 leads by 180°	114
Fig. 89: Negative flow - Channel 3 lags by 180°	114
Fig. 90: Positive flow - Channel 3 leads by 90°	114
Fig. 91: Negative flow - Channel 3 lags by 90°	114
Fig. 92: Positive flow - Channel 3 leads by 180°	115
Fig. 93: Negative flow - Channel 3 lags by 180°	115
Fig. 94: example measurement error	153
Fig. 95: Diagram 1 for gases of fluid group 1	168
Fig. 96: Diagram 1 for gases of fluid group 2	169
Fig. 97: Diagram 2 for gases of fluid group 1	169
Fig. 98: Diagram 2 for gases of fluid group 2	170
Fig. 99: Metric flange ratings, EN 1092-1 (P: Process pressure; T: Process temperature)	170
Fig. 100: ANSI flange ratings, ASME B16.5 (P: Process pressure; T: Process temperature)	171
Fig. 101: Dimensions TCMQ 6400 through TCMQ 070K	175



Fig. 102: Dimensions TCD 9010 Compact Transmitter	175
Fig. 103: Dimensions compact transmitter TCD 9100	176
Fig. 104: Dimensions Wall-Mount Electronics TCD 9200	176

12.6. List of Tables

Tab. 1: Product compatibility	7
Tab. 2: Maximum process temperature per temperature class for TCD 9010 transmitter	15
Tab. 3: Maximum allowable process fluid temperatures for TCD 9010 when used with hazardous dusts....	15
Tab. 4: Entity parameters for TCD 9010	16
Tab. 5: Maximum process temperature per temperature class for TCD 9100/9200 transmitter	17
Tab. 6: Entity parameters for TCD 9200 only	17
Tab. 7: Entity parameters for TCD 9100/9200	17
Tab. 8: Available combinations of transmitters and sensors	18
Tab. 9: Connections TCD 9010 and Link Module of the TCD 9200 transmitter.....	46
Tab. 10: Input/output configuration	55
Tab. 11: Measurement view.....	80
Tab. 12: Alarm view level 1.....	81
Tab. 13: Alarm view level 2.....	81
Tab. 14: Alarm view level 3.....	81
Tab. 15: Operating view level 1	81
Tab. 16: Operating view level 2	81
Tab. 17: Diagnostic view	82
Tab. 18: Navigation view	83
Tab. 19: Parameter edit view	83
Tab. 20: Parameter read only view	83
Tab. 21: Process values.....	98
Tab. 22: Diagnostic values	98
Tab. 23: Available configuration hardware functionality of input and output	106
Tab. 24: One on/off valve	119
Tab. 25: Two on/off valves	119
Tab. 26: Control valve.....	120
Tab. 27: Parameter settings for two on/off valves valve control.....	120
Tab. 28: Valve control parameter.....	123
Tab. 29: Inputs/outputs simulation.....	126
Tab. 30: TRICOR standard alarm classes.....	134
Tab. 31: NAMUR status signals.....	135
Tab. 32: Info icons	135
Tab. 33: Sensor diagnostic events	139
Tab. 34: Transmitter diagnostic events	151
Tab. 35: Reference conditions for flow calibrations (ISO 9104 and DIN/EN 29104).....	154
Tab. 36: Additions in the event of deviations from reference conditions	154
Tab. 37: Power supply	157
Tab. 38: Performance TCMQ.....	158
Tab. 39: Modbus communication.....	158
Tab. 40: HART communication	159
Tab. 41: HART communication	159
Tab. 42: Digital input	159
Tab. 43: Current output (Channel 1)	160



Tab. 44: Current output (Channels 2 to 4)	160
Tab. 45: Digital output.....	161
Tab. 46: Relay output	161
Tab. 47: Designated use	161
Tab. 48: Construction	161
Tab. 49: Transmitter design.....	162
Tab. 50: Sensor design.....	162
Tab. 51: Sensor cable, basic data.....	163
Tab. 52: Signal cable recommendations (Electrical data at reference temperature (20 °C [68 °F])).....	163
Tab. 53: Signal cable recommendations.....	164
Tab. 54: Transmitter cable glands and entries	164
Tab. 55: Basic conditions	165
Tab. 56: Cleaning and sterilizing conditions	165
Tab. 57: Process media conditions	165
Tab. 58: Process variables	166
Tab. 59: HART, MODBUS and Profibus communication.....	166
Tab. 60: SD-Card	166
Tab. 61: Fluids group 1 according to PED	167
Tab. 62: Pressure - temperature rating according to EN1092-1	171
Tab. 63: Pressure - temperature rating according to ISO228-G and ASME B1.20.1 NPT	171
Tab. 64: Pressure - temperature rating according to ASME B16.5	172
Tab. 65: Pressure - temperature rating according to JIS.....	172
Tab. 66: Pressure - temperature rating according to DIN 11851	172
Tab. 67: Pressure - temperature rating according to DIN 32676 & ISO 2852	173
Tab. 68: Pressure - temperature rating according to ISO 2853.....	173
Tab. 69: Pressure - temperature rating according to DIN 11864-1.....	173
Tab. 70: Pressure - temperature rating according to DIN 11864-2.....	173
Tab. 71: Pressure - temperature rating according to DIN 11864-3.....	174
Tab. 72: Pressure - temperature rating according to Swagelok SS-12-VCO-3 socket weld with SS-12-VCO-4 nut	174
Tab. 73: Certificates TCMQ Series	178
Tab. 74: Main menu.....	181
Tab. 75: Menu items "Sensor": basic settings.....	182
Tab. 76: Menu items "Process values"	185
Tab. 77: Menu items "Totalizer"	187
Tab. 78: Menu items "Current output on CH1"	187
Tab. 79: Menu items "Signal output on CH2"	189
Tab. 80: Menu items "Input/output on CH3"	191
Tab. 81: Menu items "Input/output on CH4"	193
Tab. 82: Menu items "Dosing"	193
Tab. 83: Menu items "Recipe 1"	194
Tab. 84: Menu items "Recipe 2"	195
Tab. 85: Menu items "Recipe 3"	196
Tab. 86: Menu items "Recipe 4"	197
Tab. 87: Menu items "Recipe 5"	198
Tab. 88: Menu items "Date and time"	198
Tab. 89: Menu items "Display"	200
Tab. 90: Menu items "Identification"	201
Tab. 91: Menu items "Diagnostic events"	202
Tab. 92: Menu items "Maintenance"	202
Tab. 93: Menu items "Diagnostic"	204
Tab. 94: Menu items "Peak values"	205



Tab. 95: Menu items “Characteristics”	205
Tab. 96: Menu items “SD-Card”	206
Tab. 97: Menu items “Simulation”	207
Tab. 98: Menu items “Audit trail”	208
Tab. 99: Menu items “Self test”	208
Tab. 100: Menu items “Resets”	208
Tab. 101: Menu items “Firmware update”	208
Tab. 102: Menu items “Communication”	210
Tab. 103: Menu items “Security”	210



12.7. Subject Catalog

A

Accuracy	158
Alarm classes, overview	134
Alarm symbols, overview	134
Approval nameplate	
Sensor	62
Transmitter	62
Audit trail	209

C

Cable specifications	44, 163
Certificates	10, 178
Characteristics	206
Commissioning	
HMI	66
Safety	64
Wizard	66
Communication	210
Construction	161
Coriolis	
Applications	25
Measurement principle	25
Correct usage (See improper device modifications)	
Cross talk	37, 155
Current output	160, 188
Customer Support Hotline	179

D

Daten and time	199
Design	19
Transmitter	162
Designated use	161
Device	
Identification	59, 60, 61, 62
Diagnostic	204
Diagnostic events	202
Sensor	136
transmitter	140
Digital output	161
Display	199
Dosing	194

E

Electrical connection	
Cable specifications	44
In hazardous area	57
Safety	44
European Directive for pressure equipment	167

F

Firmware update	209
Flow direction	34

H

Handling	36
HART communication	159, 166
Hazardous area	
Electrical connection	57
Laws and directives	10
Hazardous locations	
Approvals	15
HMI	
Zero point adjustment	67
Hotline	179

I

Identification	201
Identification nameplate	
Sensor	60
Transmitter	59
Improper device modifications	10
Info icons	135
Installation	
Drop line	35
Gas	33
Incorrect	154
Indoor/outdoor	28
Inlet/Outlet conditions	33
Liquid	33
Location in the system	33
Mounting of sensor	36
Orienting the sensor	34
Rotate transmitter	31
Transmitter mounting	30
Upstream/Downstream	33
Interface	
HART communication	159
Modbus communication	158
Items supplied	8

L

Local display	
Turning	32
Low flow cut-off	154

M

Main menu	180
Maintenance	203
Modbus communication	158
Mounting	(See Installation)

N

NAMUR status signals	135
Navigation view	92



P

Parameter view	94
Peak values	205
PED	167
Performance	158
Power supply	157
Process values	184
Process variables	166

R

Rated operating conditions	165
Recipe 1	195
Recipe 2	196
Recipe 3	196
Recipe 4	197
Recipe 5	198
Relay output	161, 192
Repair	131
Resets	209

S

Scope of delivery	9
SD-Card	166, 207
Security	211
Self test	209
Sensor diagnostic events	136
Sensor orientation	(See Installation)
Service	131
Service information	132
Signal output	189, 190
Signal processing	26
Simulation	127, 208
Specification nameplate	

Transmitter	61
Symbols	(Refer to warning symbols)

T

Technical data	166
Construction	161
Current output	160
Designated use	161
Digital output	161
Interface	158, 159
Relay output	161
Techncial data	
Power supply	157
Test certificates	10
Totalizer	187
Transmitter	
Mounting	30
Rotate transmitter	31
Transmitter diagnostic events	140
TRICOR standard alarm classes	134

V

Vibrations	36, 155
------------	---------

W

Warning symbols	10
Wiring	(See Electrical connection)

Z

Zero point adjustment	67, 102
Automatic	102
HMI	67



NORTH & SOUTH AMERICA

AW Lake Company
2440 W. Corporate Preserve Dr. #600
Oak Creek WI 53154 | USA
+1 414 574 4300
sales@aw-lake.com
www.aw-lake.com

ASIA PACIFIC & MIDDLE EAST

KEM Küppers Elektromechanik GmbH
Liebigstraße 5
85757 Karlsfeld | Germany
+49 8131 59391-0
info@kem-kueppers.com
www.kem-kueppers.com

EUROPE (ROW)

KEM Küppers Elektromechanik GmbH
Liebigstraße 5
85757 Karlsfeld | Germany
+49 8131 59391-100
sales@kem-kueppers.com
www.kem-kueppers.com

CHINA

KEM flow technology (Beijing) Co., Ltd.
Rm. 906, Block C, Ruipu Office Bldg, No. 15
HongJunYingNan Road
Chaoyang District, Beijing 100012 | China
+86 10 84929567
sales@kem-kueppers.com
www.kem-kueppers.cn

